

Technical Manual



MDT Binary Input MDT Universal Interface

| Potential-free | 24VAC/DC | 230VAC |
|----------------|-------------|-------------|
| BE-04000.02 | BE-04024.02 | BE-04230.02 |
| BE-08000.02 | BE-08024.02 | BE-08230.02 |
| BE-16000.02 | BE-16024.02 | BE-16230.02 |
| BE-32000.02 | | |
| BE-02001.02 | | BE-02230.02 |
| BE-04001.02 | | |
| BE-06001.02 | | |

Further Documents:

Datasheets:

https://www.mdt.de/EN_Downloads_Datasheets.html

Assembly and Operating Instructions:

https://www.mdt.de/EN_Downloads_Instructions.html

Solution Proposals for MDT products:

https://www.mdt.de/EN_Downloads_Solutions.html

1 Content

| | |
|--|-----------|
| 1 Content | 2 |
| 2 Overview | 4 |
| 2.1 Overview Devices | 4 |
| 2.2 Connection diagrams | 5 |
| 2.3 Structure & Handling | 8 |
| 2.3.1 Binary Input..... | 8 |
| 2.3.2 Universal Interface | 9 |
| 2.4 Functional Description | 10 |
| 2.4.1 Special features..... | 10 |
| 2.5 Commissioning..... | 11 |
| 3 Communication objects | 12 |
| 3.1 Standard settings of the communication objects | 12 |
| 4 Reference-ETS-Parameter | 17 |
| 4.1 General Settings | 17 |
| 4.2 Activate inputs..... | 19 |
| 4.3 Function of Inputs | 20 |
| 4.3.1 Identical parameter | 20 |
| 4.3.1.1 Identical parameter – Lock objects..... | 20 |
| 4.3.1.2 Identical parameter – Input-/Objects description | 20 |
| 4.3.2 Switching general and Special functions..... | 21 |
| 4.3.2.1 Special functions | 23 |
| 4.3.2.1.1 Innovative group control | 23 |
| 4.3.2.1.2 Additional object | 23 |
| 4.3.2.2 Switching for grouped channels | 24 |
| 4.3.2.3 Subfunction: Switching when closing/opening | 24 |
| 4.3.2.4 Subfunction: Toggle when closing / opening / closing and opening..... | 26 |
| 4.3.2.5 Subfunction: Send Status..... | 27 |
| 4.3.3 Send contact status | 28 |
| 4.3.4 Send values..... | 32 |
| 4.3.4.1 Subfunction: Send values | 32 |
| 4.3.4.2 Subfunction: Toggle Values/Scenes (up to 4 Values)..... | 34 |
| 4.3.4.3 Subfunction: Shift Value | 37 |
| 4.3.4.4 Subfunction: Send values by state..... | 39 |
| 4.3.4.5 Subfunction: Multi-Tip Function (Send values after number of operations) | 41 |

| | |
|--|-----------|
| 4.3.5 Switch/send value short/long (with 2 objects)..... | 43 |
| 4.3.6 Scene | 45 |
| 4.3.7 Blinds/Shutter | 47 |
| 4.3.8 Dimming..... | 50 |
| 4.3.9 Counter | 51 |
| 4.3.10 LED output..... | 57 |
| 4.4. Logic..... | 58 |
| 5 Index | 61 |
| 5.1 Register of illustrations | 61 |
| 5.2 List of tables | 62 |
| 6 Appendix..... | 63 |
| 6.1 Statutory requirements | 63 |
| 6.2 Disposal..... | 63 |
| 6.3 Assembly..... | 63 |
| 6.4 History..... | 63 |

2 Overview

2.1 Overview Devices

The description refers to the following units (order number printed in bold):

- **BE-04000.02** Binary Input 4-fold, 2SU MDRC, Inputs for potential free contacts
 - **BE-08000.02** Binary Input 8-fold, 4SU MDRC, Inputs for potential free contacts
 - **BE-16000.02** Binary Input 16-fold, 8SU MDRC, Inputs for potential free contacts
 - **BE-32000.02** Binary Input 32-fold, 12SU MDRC, Inputs for potential free contacts
 - **BE-04024.02** Binary Input 4-fold, 2SU MDRC, Inputs for 24VAC/DC signals
 - **BE-08024.02** Binary Input 8-fold, 4SU MDRC, Inputs for 24VAC/DC signals
 - **BE-16024.02** Binary Input 16-fold, 8SU MDRC, Inputs for 24VAC/DC signals
 - **BE-04230.02** Binary Input 4-fold, 2SU MDRC, Inputs for 230VAC signals
 - **BE-08230.02** Binary Input 8-fold, 4SU MDRC, Inputs for 230VAC signals
 - **BE-16230.02** Binary Input 16-fold, 8SU MDRC, Inputs for 230VAC signals
-
- **BE-02001.02** Universal Interface 2-fold, Flush mounted, Inputs for potential free contacts, with LED output
 - **BE-04001.02** Universal Interface 4- fold, Flush mounted, Inputs for potential free contacts, with LED output
 - **BE-06001.02** Universal Interface 6- fold, Flush mounted, Inputs for potential free contacts, with LED output
 - **BE-02230.02** Universal Interface 2- fold, Flush mounted, Inputs for 230VAC signals

2.2 Connection diagrams

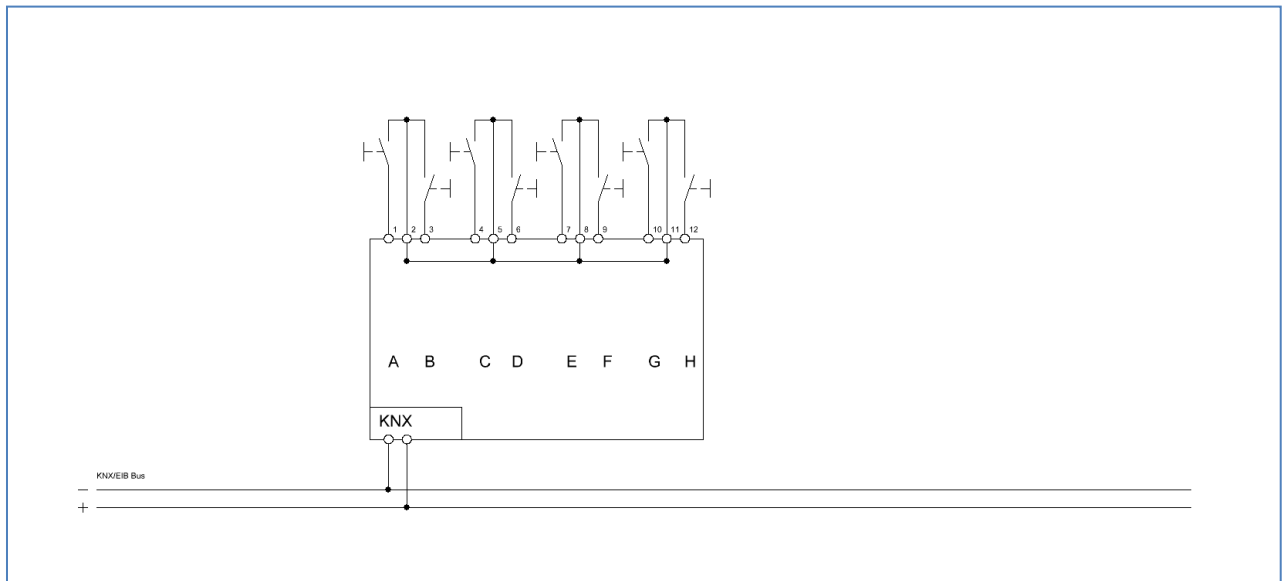

Figure 1: Connection diagram BE-08000.02 – Version for potential-free contacts

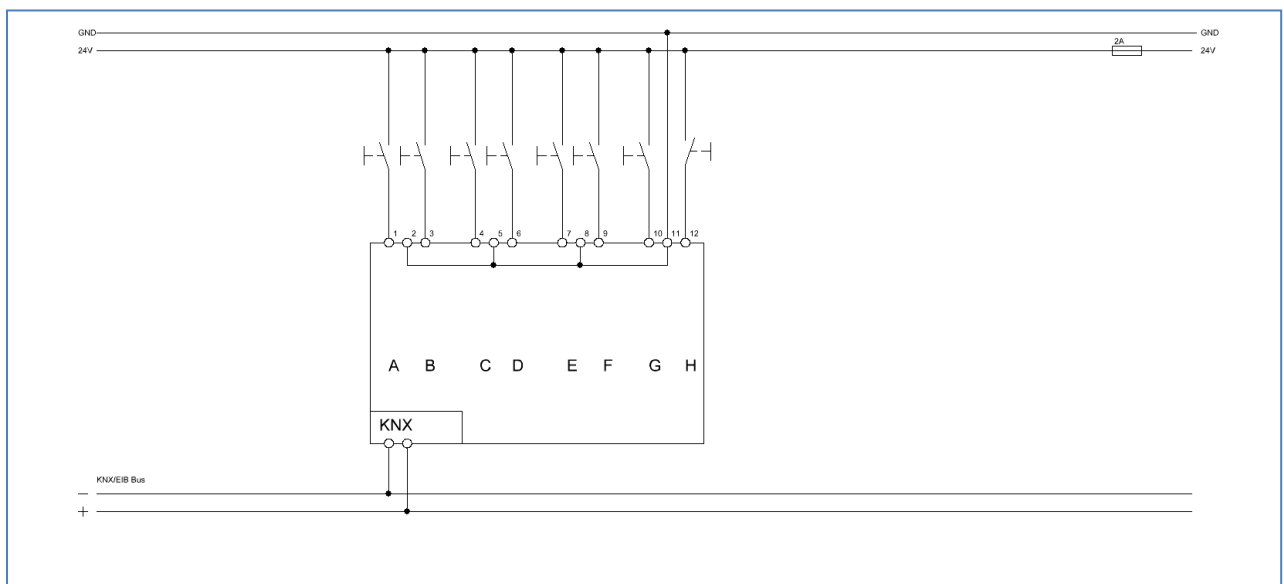

Figure 2: Connection diagram BE-08024.02 – Version for 12-24VAC/DC signals

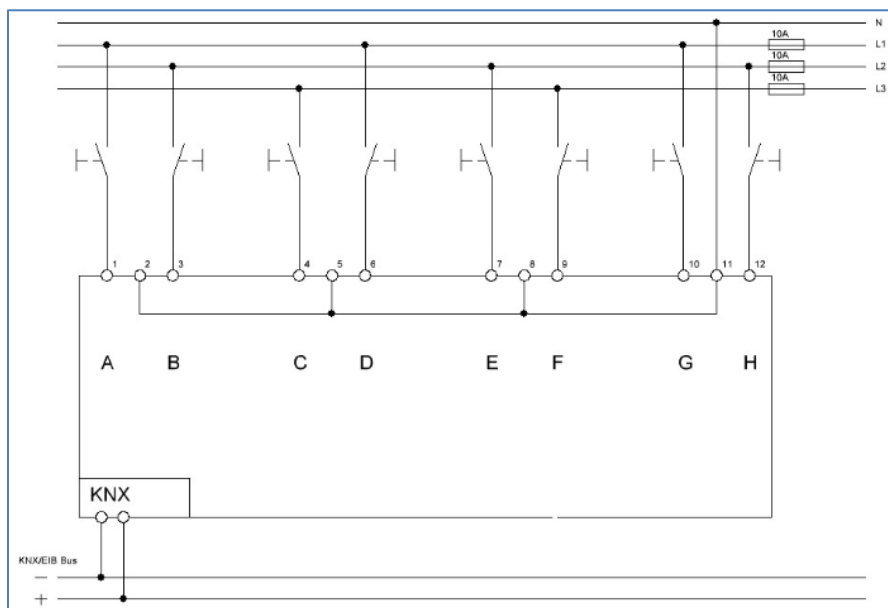

Figure 3: Connection diagram BE-08230.02 – Version for 230VAC signals

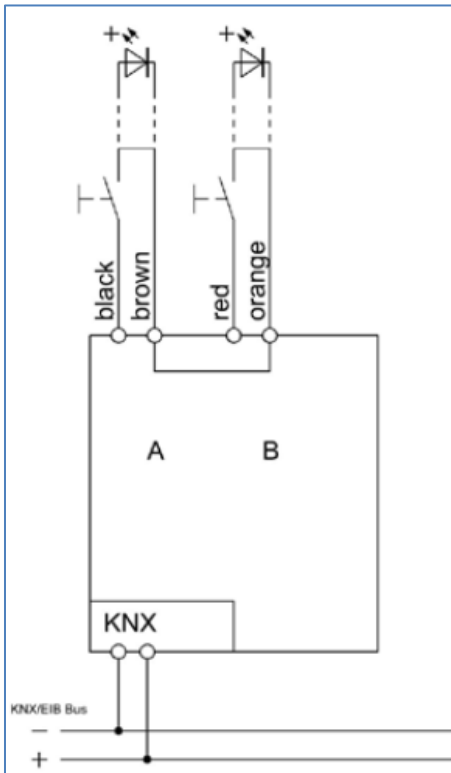

Figure 4: Connection diagram BE-02001.02

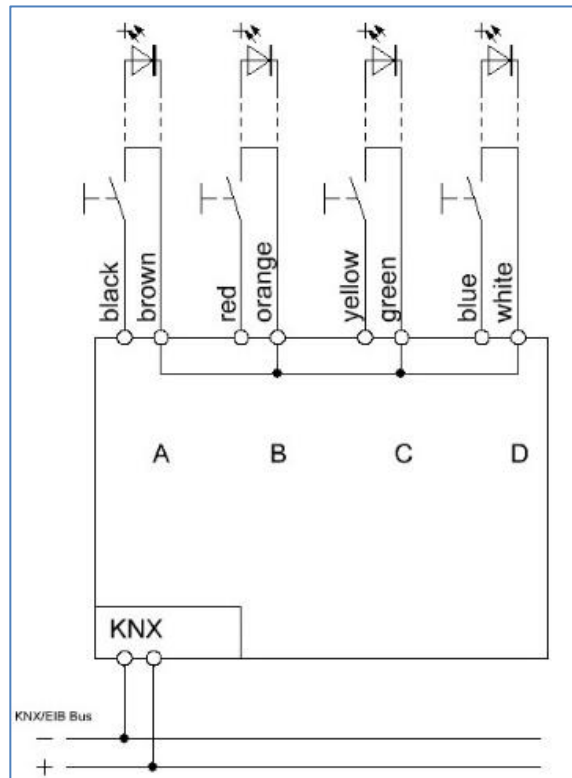

Figure 5: Connection diagram BE-04001.02

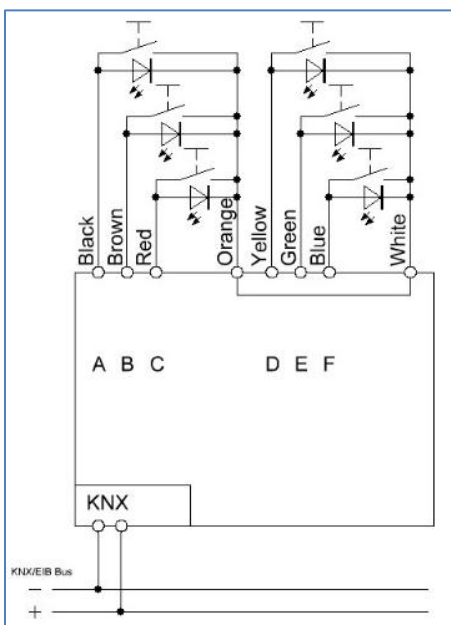

Figure 6: Connection diagram BE-06001.02

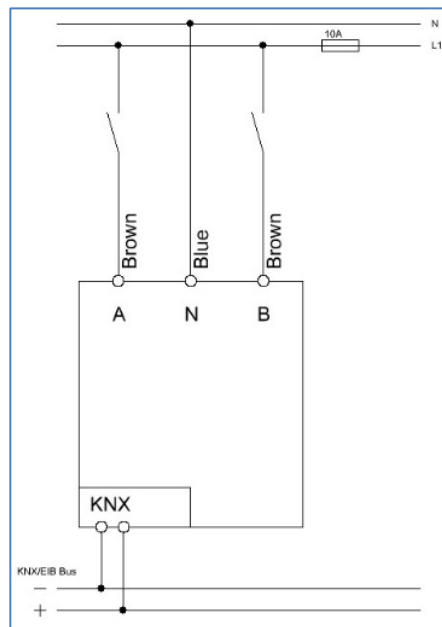

Figure 7: Connection diagram BE-02230.02

2.3 Structure & Handling

2.3.1 Binary Input

The binary inputs each have a status LED per channel, which indicates the switching state of the respective input (contact closed or voltage applied: LED=green; contact open or no voltage: LED=off).

Important:

Only the current switching status is displayed, not a possible status based on ETS programming!

The programming function is activated via the programming button when it is pressed for at least 1 second. The programming LED indicates the status whether the programming function is switched on or off.

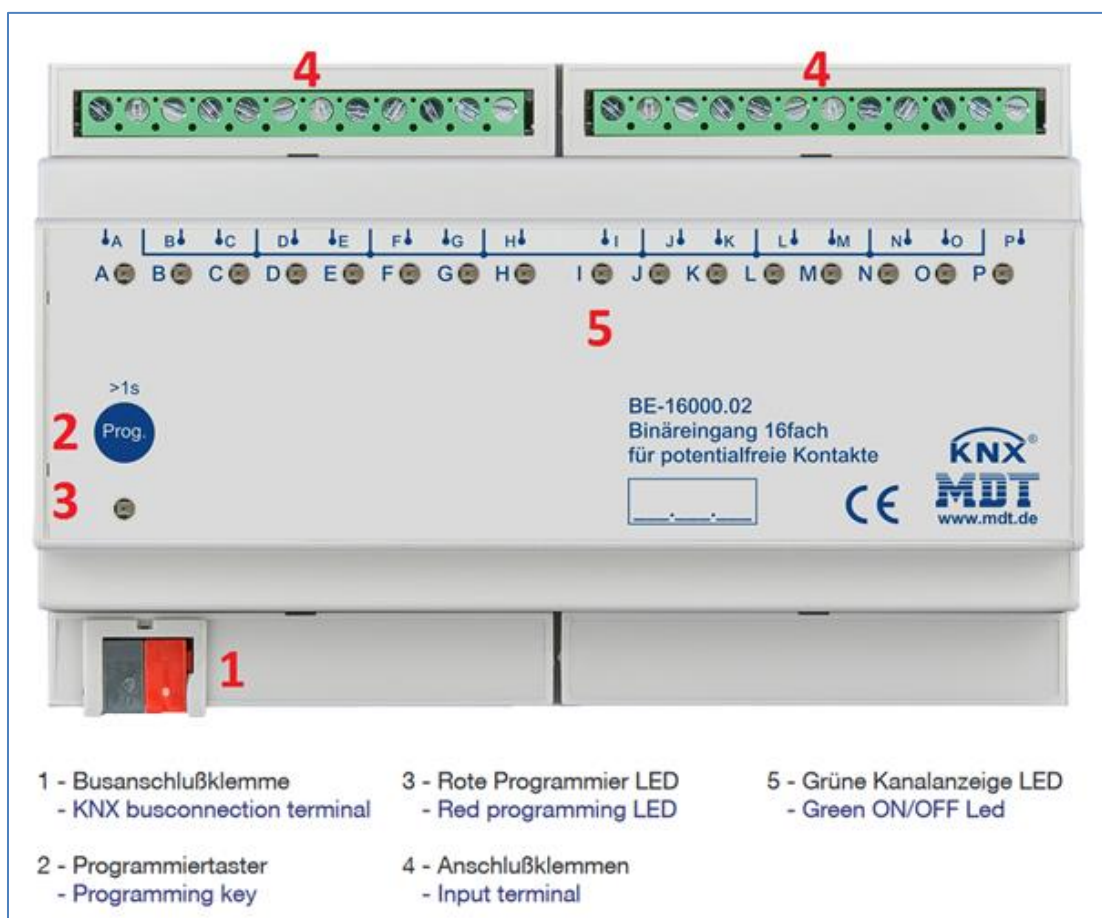

Figure 8: Structure & Handling – Binary Input (here for BE-16000.02)

Special feature of the BE-32000.02:

The status LEDs are divided into two groups of 16 channels each (A1-P1 and A2-P2). By pressing the buttons "A1-P1" or "A2-P2" the status of the channels of the respective group is displayed with the 16 status LEDs.

2.3.2 Universal Interface

The Universal Interface has a separate connection line for each of the inputs and outputs. The individual connection lines are marked in different colors. Color assignment of the connection cables for the respective channels, see [2.2 Connection diagrams](#).

The programming function is activated via the programming button. The programming LED indicates the status whether the programming function is switched On or Off.

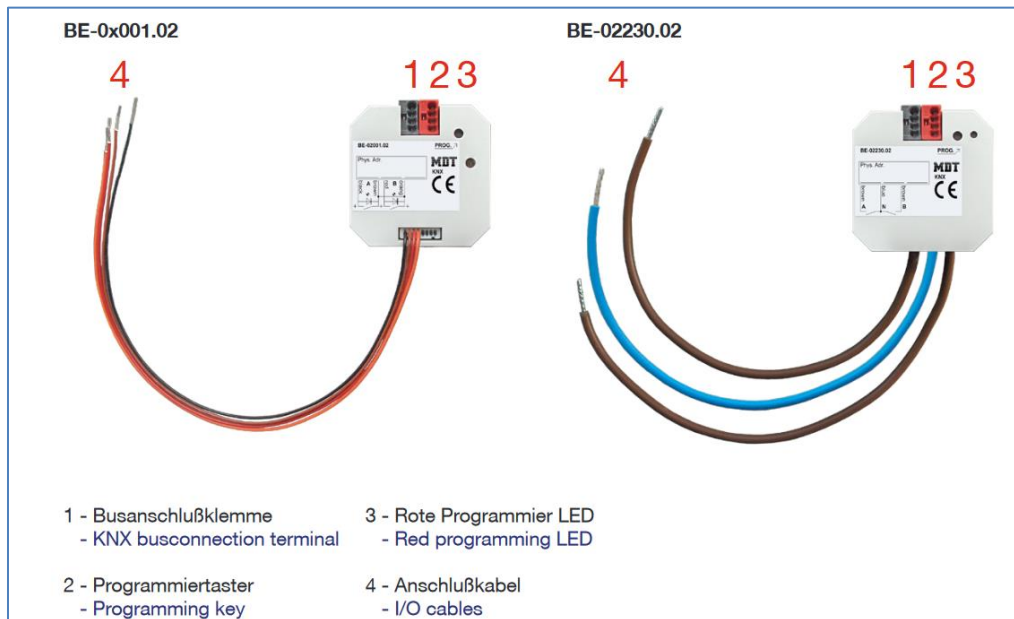

Figure 9: Structure & Handling – Universal Interface

2.4 Functional Description

The Binary Inputs are suitable for connecting push buttons, switches, and window contacts, and are designed for installation in the control cabinet. The functions of the devices are divided into the general settings, the functions for the inputs (grouped channels or individual channels) and the settings for the logic function.

The Universal Interface is a special form of the Binary Input and is used for flush mounting behind a push button/switch. It has the same functions as a Binary Input and additionally a configurable LED output.

The switching thresholds of the devices are:

- 24V Version: typ. 8V AC, typ. 10V DC
- 230V Version: typ. 165V AC

2.4.1 Special features

Binary Input and Universal Interface have a very extensive application with the following special features:

Extensive application

The functional range of the application exceeds that of a "normal" binary input many times over. Thus, in addition to the usual functions, such as blinds, switching, dimming, scene, the user also has functions for controlling various values as well as e.g., RGB/HSV colour values, colour temperature, etc. available. The inputs have in addition to a long keystroke also an extra-long keystroke. Furthermore, it is possible, for example, to send up to 4 values with one input via the multiple tap function via the same or different objects.

Innovative group control

With the function group long/extra-long keypress it is possible to send telegrams via separate communication objects by means of a long and/or extra-long keypress. This can be used for a group function, for example. With the short keystroke the room is switched on/off, with the long keystroke the floor and with the extra-long keystroke the building.

Logic function

A total of 4 (for 2/4/6/8/16-fold devices) or 8 (for 32-fold Binary Input) logic functions can also be used to implement a variety of function calls. The logic function can process both internal and external statuses.

Counter function

With the counter function, in addition to pulse telegrams, a simple counter for different data point types as well as a consumption counter for different measured variables such as water/gas (m³) or power (kWh) can be realized.

LED outputs (*only available for Universal Interface*)

The channels can also be configured as LED output (for "low current" LED).

Long Frame Support

The devices support the sending of longer telegrams and thus the storage of more user data per telegram. This significantly shortens the programming time (from ETS5).

Requirements: Use of a programming interface which supports the transmission of long frames, e.g., MDT SCN-USBR.02 or SCN-IP000.03 / SCN-IP100.03.

2.5 Commissioning

After wiring, the allocation of the physical address and the parameterization of every channel follow:

- (1) Connect the interface with the bus, e.g., MDT USB interface.
- (2) Switch on the bus voltage.
- (3) Press the programming button at the device >1s (red programming LED lights).
- (4) Loading of the physical address out of the ETS-Software by using the interface (red LED goes out, as well this process was completed successful).
- (5) Loading of the application, with requested configuration.
- (6) If the device is enabled, you can test the requested functions (also possible by using the ETS-Software).

3 Communication objects

3.1 Standard settings of the communication objects

The following table shows the default settings for the communication objects:

| Standard settings – Inputs | | | | | | | | | |
|----------------------------|----------------------------------|--|---|---|---|---|---|---|--|
| No. | Channel/Input | Object Function | Length | C | R | W | T | U | |
| 0 | Input A Input A/B | Switch | 1 Bit | X | | | X | | |
| 0 | Input A | Toggle | 1 Bit | X | | | X | | |
| 0 | Input A | Send status | 1 Bit | X | X | | X | | |
| 0 | Input A Input A/B | Forcible control | 2 Bit | X | | | X | | |
| 0 | Input A Input A/B | Percent value Decimal value Scene | 1 Byte | X | | | X | | |
| 0 | Input A Input A/B | Colour temperature Temperature value Brightness value | 2 Byte | X | | | X | | |
| 0 | Input A Input A/B | RGB value HSV value | 3 Byte | X | | | X | | |
| 0 | Input A | Counting pulse | 1 Bit | X | | | X | | |
| 0 | Input A | Threshold counter | 1 Bit | X | X | | X | | |
| 0 | Input A | Counter reading | 1 Byte 2 Byte 4 Byte | X | X | X | X | | |
| 0 | Input A Input A/B | Dimming On/Off | 1 Bit | X | | | X | | |
| 0 | Input A Input A/B | Blinds Up/Down | 1 Bit | X | | | X | | |
| 0 | Input A short Input A/B short | Switch | 1 Bit | X | | | X | | |
| 0 | Input A short Input A/B short | Toggle | 1 Bit | X | | | X | | |
| 0 | Input A short Input A/B short | Forcible control Percent value Decimal value Scene Colour temperature Temperature value Brightness value RGB value HSV value | 2 Bit 1 Byte 1 Byte 1 Byte 2 Byte 2 Byte 2 Byte 3 Byte 3 Byte | X | | | X | | |

| | | | | | | | | |
|---|----------------------------------|--|--|---|---|---|---|---|
| 0 | Input A, tip once | Switch Forcible control Percent value Decimal value Scene Colour temperature Temperature value Brightness value RGB value HSV value | 1 Bit 2 Bit 1 Byte 1 Byte 1 Byte 2 Byte 2 Byte 2 Byte 3 Byte 3 Byte | X | | | X | |
| 0 | LED output A | Switch | 1 Bit | X | | X | | |
| 1 | Input A | Status for toggle | 1 Bit | X | | X | X | X |
| 1 | Input A Input A/B | Stop/Slats Open/Close | 1 Bit | X | | | X | |
| 1 | Input A Input A/B | Dimming relative | 4 Bit | X | | | X | |
| 1 | Input A | Momentary value | 1 Byte 2 Byte 4 Byte | X | X | | X | |
| 1 | Input A | Flow rate | 2 Byte 4 Byte | X | X | | X | |
| 1 | Input A | Electrical power | 2 Byte 4 Byte | X | X | | X | |
| 1 | Input A Input A/B | Status of percent value Status of decimal value Status of colour temperature Status of temperature Status of brightness | 1 Byte 1 Byte 2 Byte 2 Byte 2 Byte | X | | X | X | X |
| 1 | Input A, tip twice | Switch Forcible control Percent value Decimal value Scene Colour temperature Temperature value Brightness value RGB value HSV value | 1 Bit 2 Bit 1 Byte 1 Byte 1 Byte 2 Byte 2 Byte 2 Byte 3 Byte 3 Byte | X | | | X | |
| 1 | Input A short Input A/B short | Status for toggle | 1 Bit | X | | X | X | X |
| 2 | Input A | Scene | 1 Byte | X | | | X | |
| 2 | Input A | Status for toggle | 1 Bit | X | | X | X | X |
| 2 | Input A | Status for change of direction | 1 Bit | X | | X | X | X |
| 2 | Input A | Reset counter | 1 Bit | X | | X | X | |

| | | | | | | | | |
|---|--|--|--|---|--|--|---|--|
| 2 | Input A, Additional object Input A/B Additional object | Switch | 1 Bit | X | | | X | |
| 2 | Input A, Additional object Input A/B Additional object | Toggle | 1 Bit | X | | | X | |
| 2 | Input A, Additional object Input A/B Additional object | Send status | 1 Bit | X | | | X | |
| 2 | Input A, Additional object Input A/B Additional object | Switching inverted | 1 Bit | X | | | X | |
| 2 | Input A, Additional object Input A/B Additional object | Toggle inverted | 1 Bit | X | | | X | |
| 2 | Input A, Additional object Input A/B Additional object | Send status inverted | 1 Bit | X | | | X | |
| 2 | Input A long Input A/B long | Switch Forcible control Percent value Decimal value Scene Colour temperature Temperature value Brightness value RGB value HSV value | 1 Bit 2 Bit 1 Byte 1 Byte 1 Byte 2 Byte 2 Byte 2 Byte 3 Byte 3 Byte | X | | | X | |
| 2 | Input A Group long Input A/B Group long | Switch Forcible control Percent value Decimal value Scene Colour temperature Temperature value Brightness value RGB value HSV value | 1 Bit 2 Bit 1 Byte 1 Byte 1 Byte 2 Byte 2 Byte 2 Byte 3 Byte 3 Byte | X | | | X | |
| 2 | Input A, Additional object Input A/B, Additional object | Switch Forcible control Percent value Decimal value Scene Colour temperature Temperature value Brightness value RGB value HSV value | 1 Bit 2 Bit 1 Byte 1 Byte 1 Byte 2 Byte 2 Byte 2 Byte 3 Byte 3 Byte | X | | | X | |

| | | | | | | | | |
|------------|--|--|--|---|--|---|---|---|
| 2 | Input A, tip triple | Switch Forcible control Percent value Decimal value Scene Colour temperature Temperature value Brightness value RGB value HSV value | 1 Bit 2 Bit 1 Byte 1 Byte 1 Byte 2 Byte 2 Byte 2 Byte 3 Byte 3 Byte | X | | | X | |
| 3 | Input A/B | Status of percent value | 1 Byte | X | | X | | X |
| 3 | Input A/B | Status of decimal value | 1 Byte | X | | X | | X |
| 3 | Input A long Input A/B long | Status for toggle | 1 Bit | X | | X | X | X |
| 3 | Input A long | Switch Forcible control Percent value Decimal value Scene Colour temperature Temperature value Brightness value RGB value HSV value | 1 Bit 2 Bit 1 Byte 1 Byte 1 Byte 2 Byte 2 Byte 2 Byte 3 Byte 3 Byte | X | | | X | |
| 3 | Input A Group extra-long | Blinds Up/Down | 1 Bit | X | | | X | |
| 4 | Input A Group extra-long Input A/B Group extra-long | Switch Forcible control Percent value Decimal value Scene Colour temperature Temperature value Brightness value RGB value HSV value | 1 Bit 2 Bit 1 Byte 1 Byte 1 Byte 2 Byte 2 Byte 2 Byte 3 Byte 3 Byte | X | | | X | |
| 4 | Input A Group extra-long | Stop/Slats Open/Close | 1 Bit | X | | | X | |
| 4 | Input A Group extra-long | Toggle | 1 Bit | X | | | X | |
| 5 | Input A Input A/B | Lock object | 1 Bit | X | | X | X | X |
| + 6 | next channel/input | | | | | | | |

Table 1: Communication objects – Standard settings: Inputs

In addition to the communication objects for the channels, all devices have communication objects for the logic. These communication objects can be configured and thus displayed independently of the configuration of the individual channels. Since the logic objects appear after the channel objects, the object numbers are variable depending on the device.

The object numbers in the following table apply to the devices with 2/4/6/8/16/32 channels:

| Standard Settings – Logic | | | | | | | | |
|---------------------------|-------------------|-----------------|--------|---|---|---|---|---|
| No. | Name | Object Function | Length | C | R | W | T | U |
| 12/24/36/48/96/192 | Logic 1 | Input 1A | 1 Bit | X | | X | X | X |
| 13/25/37/49/97/193 | Logic 1 | Input 1B | 1 Bit | X | | X | X | X |
| 14/26/38/50/98/194 | Logic 1 | Output | 1 Bit | X | X | | X | |
| | | Output Scene | 1 Byte | | | | | |
| | | Output value | 2 Bit | | | | | |
| | | Output value | 1 Byte | | | | | |
| + 3 | next Logic | | | | | | | |

Table 2: Communication objects – Standard settings: Logic

The table above shows the pre-set default settings. The priority of the individual communications objects and the flags can be adjusted by the user as required. The flags assign the communication objects their respective tasks in programming, where C stands for communication, R for read, W for write, T for transmit and U for update.

4 Reference-ETS-Parameter

4.1 General Settings

The following picture shows the menu for the general settings:

The screenshot shows a settings menu with the following items:

- Startup time: 2 s
- Send "Operation" cyclically: not active
- Behavior after bus power return:
 - Input values for logics: no request, request
 - Status for toggle: no request, request
- Configuration of inputs:
 - Debounce time: 30 ms
 - Time for long keypress (Basic setting): 0,5 s

Figure 10: General Settings

The following table shows the possible settings:

| ETS-Text | Dynamic range [Default value] | Comment |
|---|--|---|
| Startup time | 2 – 240 s [2 s] | Sets the time between restart and functional start-up of the device. |
| Send „Operation“ cyclically | not active 1 min – 24 h | Setting whether and at what interval a cyclical "In operation" telegram should be sent. |
| Behaviour after bus power return | | |
| Input values for logics | <ul style="list-style-type: none"> ▪ no request ▪ request | Setting whether the values/objects should be requested automatically on bus voltage return. |
| Status for toggle | <ul style="list-style-type: none"> ▪ no request ▪ request | |
| Configuration of inputs | | |
| Debounce time | 10 – 150 ms [30 ms] | With this time the inputs are debounced. |
| Time for long keypress (Basic setting) | 0,1 s – 30 s [0,5 s] | Setting from when a long keystroke is detected. |

Table 3: General Settings

Behaviour after bus power return

If "Input values for logics" - "request" is active, the external objects of the activated logics are requested for their status and the logic operation is re-evaluated. If no response is received, the default values apply. If the query is not active, the inputs are not current. Then the pre-settings of the external logic objects are valid.

The setting "Status for toggle – request" causes all communication objects "Status for toggle" to be requested in the event of bus voltage recovery. If this parameter is not activated, the device assumes an unactuated status for all these objects. This means that the device does not respond to the current status of the actuator during the next switchover but sends a "1" in any case. However, if the objects are requested, the device checks the current status of the "toggle objects" when the bus voltage returns and can safely toggle the actuator to be controlled with the next command.

Debounce time

In the case of electromechanical switches, actuation of the switch briefly causes the contact to close and open several times. This is caused by elastic bouncing back against the suspension. By setting a debounce time, this effect is intercepted, and the signal is sent only slightly delayed. If multiple On/Off telegrams are still being sent to the bus, the time has to be increased.

Time for long keypress

With the help of the "Time long keypress" parameter, a fixed time value can be assigned to the device, from when it recognizes a keypress as long. This parameter is important for objects that have functions for both a short and a long keystroke. The set time applies to all inputs unless an individual time has been assigned there.

4.2 Activate inputs

The following settings are available for this menu (here for BE-16000.02):

| | |
|----------------------|------------------|
| Function Input A / B | channels single |
| Function Input C / D | channels grouped |
| Function Input E / F | not active |
| Function Input G / H | not active |
| Function Input I / J | not active |
| Function Input K / L | not active |
| Function Input M / N | not active |
| Function Input O / P | channels single |

Figure 11: Settings – Activate inputs

The following table shows the possible settings:

| ETS-Text | Dynamic range [Default value] | Comment |
|--|---|--|
| Function Input A/B – [O/P] | <ul style="list-style-type: none"> not active Channels single Channels grouped | Operating mode of the respective channels. |
| Function Input A1/B1 – O1/P1 Function Input A2/B2 – O2/P2 | <ul style="list-style-type: none"> not active Channels single Channels grouped | Operating mode of the respective channels. A2/B2 – O2/P2: only available with BE-32000.02. |

Table 4: Settings – Activate inputs

3 selection options are available here for the inputs. If a channel is selected as "not active", this channel cannot be configured further.

Further configuration then depends on the selection made (single or grouped).

The designation in the "Inputs A-x" submenu depends on the device. For example, it is called "A-D" for the 4-fold device or "A-P" for the 16-fold device. The channels are named in ascending order according to ABC.

In the BE-32000.02, the inputs are divided into 2 groups, namely "A1-P1" and "A2-P2".

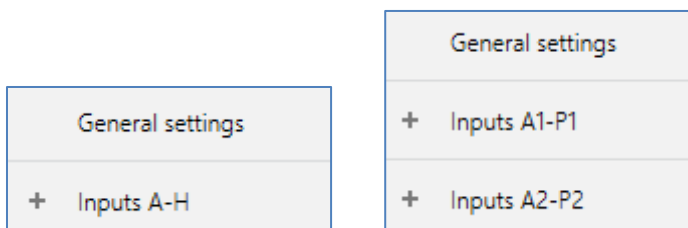

| | |
|------------------|------------------|
| General settings | General settings |
| + Inputs A-H | + Inputs A1-P1 |
| | + Inputs A2-P2 |

Figure 12: Submenu – Inputs (8-fold and 32-fold)

4.3 Function of Inputs

4.3.1 Identical parameter

4.3.1.1 Identical parameter – Lock objects

A lock object can be activated both for **grouped inputs**, for the respective channel pair, e.g. A/B, and for **single inputs**, then for the respective channel, e.g. channel A or channel B. If the lock object is active, the communication object appears for the respective input or input pair. Thus, e.g. for a binary input with 16 inputs, up to 16 lock objects can be configured. If the lock object is assigned a logical "1", the associated channel is "locked" and can therefore no longer be switched. With a logical "0", the lock is cancelled.

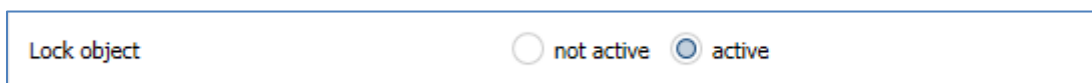

Figure 13: Identical Parameter – Lock object

| Number | Name/Object Function | Length | Usage |
|--------|----------------------|--------|--|
| 5 | Lock object | 1 Bit | Locking/unlocking the channel or channel pair. |

Table 5: Communication object – Lock object

4.3.1.2 Identical parameter – Input-/Objects description

Für einzelne- sowie für gruppierte Eingänge ist jeweils ein Textfeld zur freien Beschriftung verfügbar:

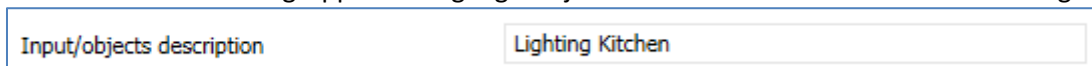

Figure 14: Identical Parameter – Text fields per input/input pair

Texts with up to 30 characters can be stored for the field.

The text entered for the **input/objects description** appears both in the menu behind the corresponding inputs and with the communication objects of the inputs.

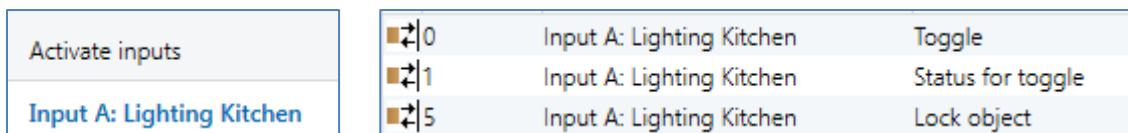

Figure 15: Example – Input/Objects description

4.3.2 Switching general and Special functions

- Channels single
- Channels grouped

The following figure shows the available settings for the Switching function, here for grouped inputs:

| | |
|---------------------------------|--|
| Function of Inputs | switch |
| Send value when | <input checked="" type="radio"/> closing <input type="radio"/> opening |
| Value 1st input / 2nd input | <input checked="" type="radio"/> On/Off <input type="radio"/> Off/On |
| Special function | innovative group control |
| innovative group control | |
| Group long keypress | <input type="radio"/> not active <input checked="" type="radio"/> active |
| Group long sends | ON and OFF |
| Group extra long keypress | <input type="radio"/> not active <input checked="" type="radio"/> active |
| Group extra long sends | ON and OFF |
| Time for long keypress | basic setting |
| Time for extra long keypress | 2,0 s |

Figure 16: General Settings – Switch and special functions

The following parameters are identical for the "Switching" input function:

| ETS-Text | Dynamic range [Default value] | Comment |
|---|--|---|
| Send value when | <ul style="list-style-type: none"> ▪ closing ▪ opening | Only for grouped channels. Defines when to send. |
| Value 1st input / 2nd input | <ul style="list-style-type: none"> ▪ ON/OFF ▪ OFF/ON | Only for grouped channels. Defines the send behaviour of the two inputs. |
| Subfunction | <ul style="list-style-type: none"> ▪ switching when closing ▪ switching when opening ▪ toggle when closing ▪ toggle when opening ▪ toggle when closing and opening ▪ send status | Only for single channels. Defines the subfunction and shows further parameters if necessary. Innovative group control only possible for "switching when closing/opening". |
| Special function | <ul style="list-style-type: none"> ▪ innovative group control ▪ additional object ▪ additional object inverted | Setting of an additional special function which can be activated. |
| Special function: Innovative group control | | |
| Group long keypress | <ul style="list-style-type: none"> ▪ ON and OFF ▪ Only ON ▪ Only OFF | Only shown when a long keypress is active! Defines the sending behaviour when a long keypress is active. For single button functions, the sending behaviour is defined according to the subfunction. |
| Group extra-long keypress | <ul style="list-style-type: none"> ▪ ON and OFF ▪ Only ON ▪ Only OFF | Only shown when a long and extra-long keypress is active! Defines the sending behaviour when a extra-long keypress is active. For single button functions, the sending behaviour is defined according to the subfunction. |
| Time for long keypress | Basic setting 0,1 s – 30,0 s | Setting from when a long keystroke is detected. Basic setting refers to the time at "General setting". |
| Time for extra-long keypress | 0,1 s – 30,0 s [2,0 s] | Setting from when an extra-long keypress is detected |
| Special function: Additional object | | |
| Additional object sends | <ul style="list-style-type: none"> ▪ ON and OFF ▪ only ON ▪ only OFF | Defines the sending behaviour. For single channels, the value is sent according to the subfunction. |
| Special function: Additional object inverted | | |
| Additional object sends inverted | <ul style="list-style-type: none"> ▪ ON and OFF ▪ only ON ▪ only OFF | Defines the sending behaviour. For single channels, the value is sent according to the subfunction. |

Figure 17: General Settings – Switch and special functions

4.3.2.1 Special functions

Various special functions can be activated in addition to the normal switching function:

- Innovative group control
- Additional object
- Additional object inverted

These functions are all selectable for grouped channels. For single channels the selection is partly limited depending on the subfunction.

4.3.2.1.1 Innovative group control

One group for long keypress and one group for extra-long keypress can be activated in each case. After activation, the corresponding communication objects appear. The times for the long and the extra-long keystroke can be configured individually. It is recommended to select the time differences sufficiently to avoid false triggering.

For grouped channels, it is possible to filter which value is to be sent for "Group long" and "Group extra-long" respectively.

There is no selection for single channels because the value to be sent always refers to the value that is set directly for the subfunction. If, for example, the value "1" is set for the "Switching on closing" subfunction, this value is also sent for "Group long keypress" and "Group extra-long keypress".

A separate communication object is available for each group.

For example, a short press can be used to switch a single spotlight, a long press to switch another spotlight, and an extra-long press to switch the main light in the room.

Important: All groups are always sent one after the other.

Example:

Send value when: closing the contact

Time long key press: 2 s

Time extra-long key press: 4 s

If the input is closed (key is pressed) for at least 4 seconds, the first value is transmitted immediately, after 2 seconds the value for "group long" and after 4 seconds the value for "group extra-long".

4.3.2.1.2 Additional object

An additional communication object is shown here. This allows the switching command to be sent to a different group address, for example.

For grouped channels, the send behavior can be filtered, i.e. which value is to be sent.

No selection possible for single channels. The value refers to the value of the subfunction.

Important: When a key is pressed, the commands are always sent to the normal object as well as to the additional object at the same time.

Additional object inverted:

An additional communication object is also shown here which sends the value of the switching command inverted. This is helpful if, for example, when sending a "1" for switching, a "0" for another function is required at the same time.

The further behavior corresponds to that of "additional object".

4.3.2.2 Switching for grouped channels

Channels grouped

With the switching function for grouped channels, it can be defined on the one hand whether the value is to be sent when opening or closing, and on the other hand which value (On/Off) is to be sent. Thus, the respective input sends a defined value.

The following figure shows the available settings:

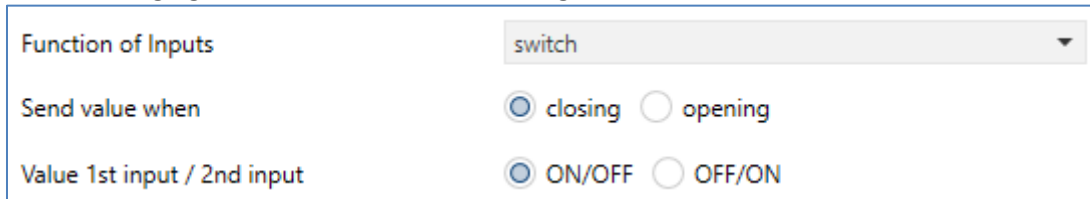

Figure 18: Settings – Switching for grouped channels

Input assignment ON/OFF: Input 1 sends the value ON and input 2 the value OFF.

Input assignment OFF/ON: Input 1 sends the value OFF and input 2 the value ON.

Details about "Special functions", see [4.3.2.1 Special functions](#)

The following table shows the associated communication objects:

| Number | Name/Object Function | Length | Usage |
|--------|--|--------|---|
| 0 | Input A/B – Switch | 1 Bit | Switching function of the channels |
| 2 | Input A/B Group long – Switch | 1 Bit | Switching function with long keypress |
| 2 | Input A/B Additional object – Switch | 1 Bit | Switching function for additional object |
| 2 | Input A/B Additional object – Switching inverted | 1 Bit | Switching function for additional object inverted |
| 4 | Input A/B Group extra-long – Switch | 1 Bit | Switching function with extra-long keypress |

Table 6: Communication objects – Switching for grouped channels

4.3.2.3 Subfunction: Switching when closing/opening

Channels single

With the single channel function " Switch - Subfunction: Switching when closing/opening", the channel sends the respective fixed set value when a rising or falling edge is received.

The following figure shows the available settings (here: switching when closing):

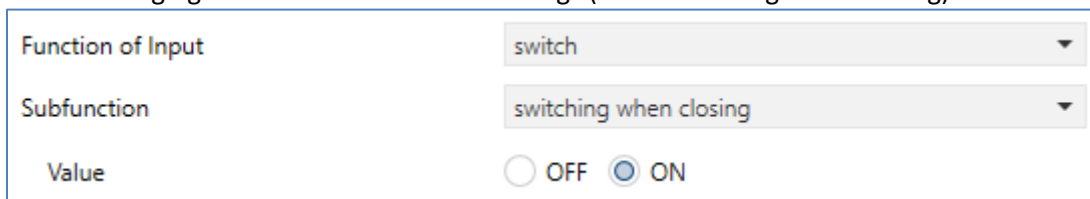

Figure 19: Settings – Subfunction: Switching when closing/opening

With this setting, a "1" signal is only sent on a rising edge (closing) or falling edge (opening). No "0" signal would be sent on a falling edge.

The behaviour for sending the value "Off" is corresponding ("0" would be sent, "1" not).

The following diagram describes this subfunction for rising edge (closing). As soon as the state of the input changes from “0” to “1”, the binary input sends a “1”:

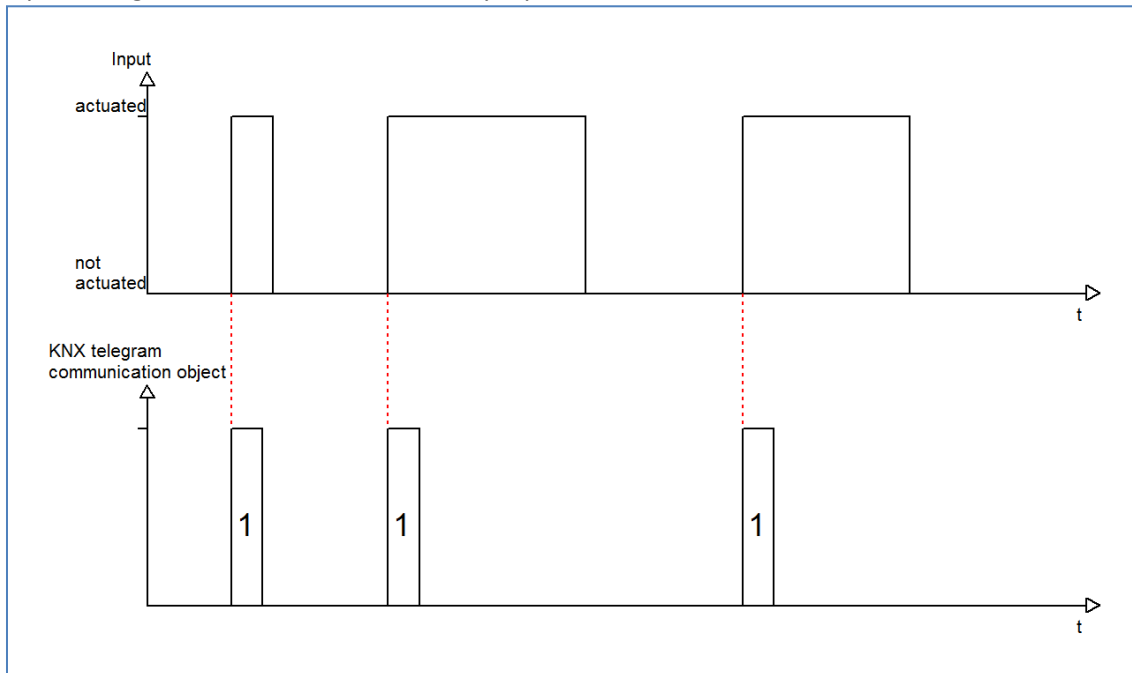

Figure 20: Diagram – Switching when closing (rising edge)

Details about "Special functions", see [4.3.2.1 Special functions](#)

The following table shows the associated communication objects:

| Number | Name/Object Function | Length | Usage |
|--------|--|--------|---|
| 0 | Input A/B – Switch | 1 Bit | Switching function of the channels |
| 2 | Input A/B Group long – Switch | 1 Bit | Switching function with long keypress |
| 2 | Input A/B Additional object – Switch | 1 Bit | Switching function for additional object |
| 2 | Input A/B Additional object – Switching inverted | 1 Bit | Switching function for additional object inverted |
| 4 | Input A/B Group extra-long – Switch | 1 Bit | Switching function with extra-long keypress |

Table 7: Communication objects – Switching when closing/opening

4.3.2.4 Subfunction: Toggle when closing / opening / closing and opening

Channels single

With the subfunction "Toggle when closing" or "Toggle when opening", the input switches by the corresponding edge in each case. This means that the current object value is inverted in each case and then sent. This function can be used, for example, to set up an edge-controlled changeover circuit. With the sub-function "Toggle when closing and opening", a toggle pulse is triggered on both edges.

The following image shows the available settings (here: Toggle when closing):

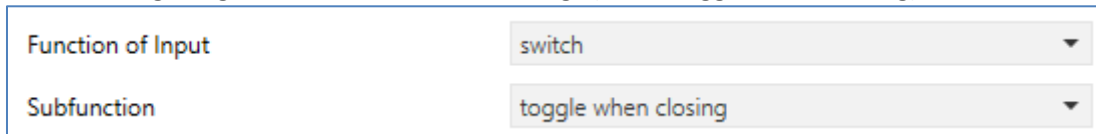

Figure 21: Settings – Toggle when closing / opening / closing and opening

The following diagram describes the subfunction "Switching when opening". As soon as the state changes from "1" to "0", the binary input outputs the opposite signal to the previous signal. The signal is output in the form of a short pulse in each case:

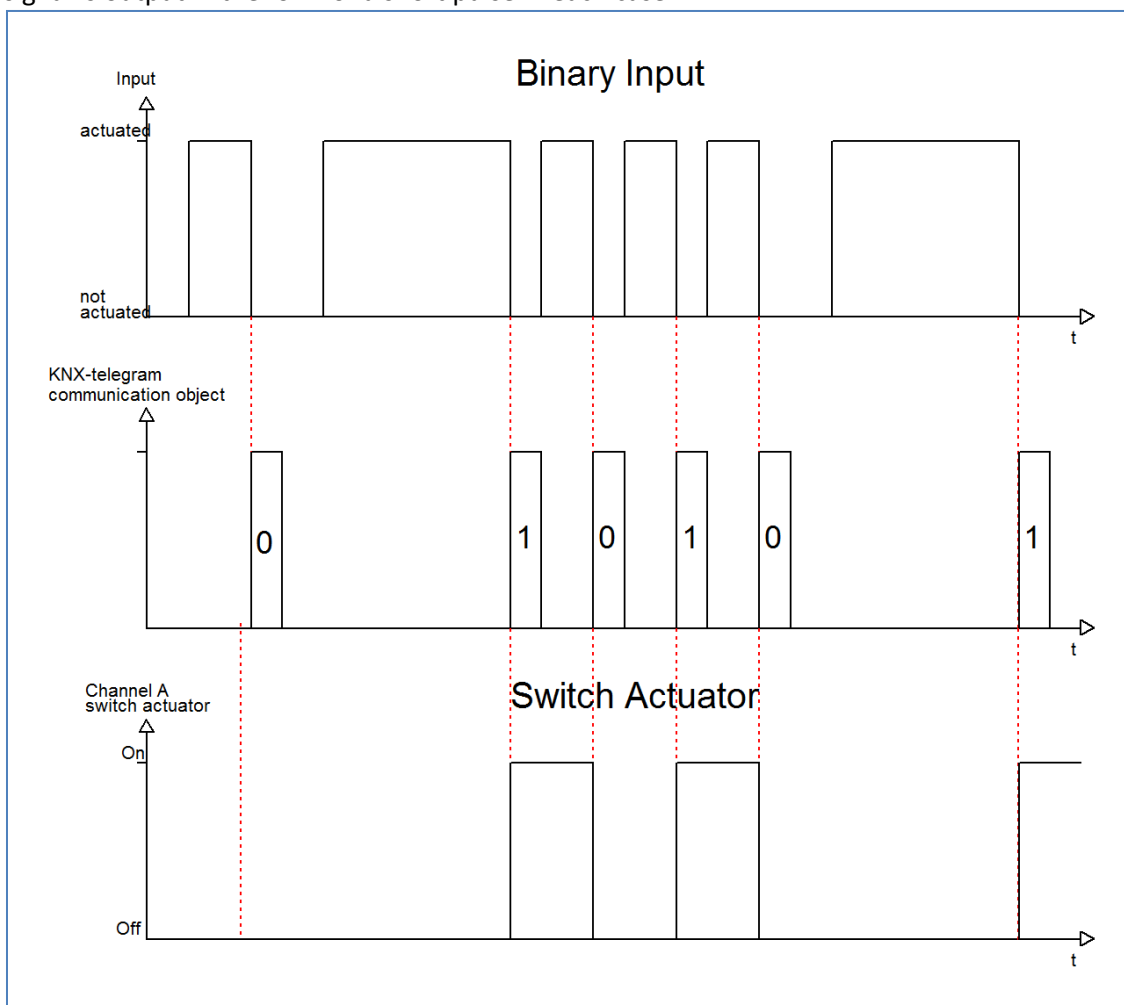

Figure 22: Diagram – Toggle when opening

In addition, the special functions are available ([4.3.2 Switching general and Special function](#)).

The following table shows the associated communication objects:

| Number | Name/Object Function | Length | Usage |
|--------|---|--------|--|
| 0 | Input A – Toggle | 1 Bit | Switching function of the channel |
| 1 | Input A – Status for toggle | 1 Bit | Status to update the button. Must be connected to the status of the actuator to be switched so that the correct (inverted) value is always sent out. |
| 2 | Input A group lang – toggle | 1 Bit | Switching function with long keystroke. Not available with "Toggle when closing and opening". |
| 2 | Input A Additional object – toggle | 1 Bit | Switching function for additional object. |
| 2 | Input A Additional object – toggle inverted | 1 Bit | Switching function for additional object inverted. |
| 4 | Input A group extra lang – toggle | 1 Bit | Switching function with extra-long keystroke. Not available with "Toggle when closing and opening". |

Table 8: Communication objects – Toggle when closing / opening / closing and opening

So that the respective input for the switch-over knows its last switching state, the object "**Status for toggle**" must be linked with the status object of the switch actuator. If the binary input is to be operated/tested without an actuator, this object must be linked with the "Switching" object so that the switchover functions.

By decoupling the two communication objects, it is possible with our binary inputs to visualise the switching process by linking it to the communication object "Status for toggle". In this way, the user is freer in his design options.

For example, the switching operation can be displayed via an LED or a display for visualisation by linking the communication object with the respective visualisation element.

4.3.2.5 Subfunction: Send Status

Channels single

This function is described in the next chapter, "[4.3.3 Send contact status](#)".

The settings are internally linked and the same. Changes in the configuration have a parallel effect on both functions.

4.3.3 Send contact status

Channels single

With the function "Send contact status", fixed values can be sent for a closed contact (rising edge) or an open contact (falling edge). This function can be used to realise tactile applications such as reed contacts on windows.

The following picture shows the available settings:

| | |
|-------------------------------|--|
| Function of Input | send contact status |
| Value for "Contact closed" | OFF |
| Value for "Contact opened" | ON |
| Send delay | active |
| Delay | 10 s |
| Cyclic sending | <input type="radio"/> not active <input checked="" type="radio"/> active |
| Send cyclically every | 5 min |
| Behaviour on bus power return | send status |
| Special function | additional object |

Figure 23: Settings – Send contact status

The following table describes the available settings:

| ETS-Text | Dynamic range [Default value] | Comment |
|----------------------------|---|---|
| Value for „Contact closed“ | <ul style="list-style-type: none"> • OFF • ON • not active | Defines the switching behaviour when the contact is closed. |
| Value for „Contact opened“ | <ul style="list-style-type: none"> • OFF • ON • not active | Defines the switching behaviour when the contact is opened. |
| Send delay | <ul style="list-style-type: none"> • not active • active • active for „Contact closed“ • active for „Contact opened“ | Settings for a send delay. |
| Delay | 1 s – 6 h [10 s] | Setting by which time the values are sent delayed. |
| Cyclic sending | <ul style="list-style-type: none"> • not active • active | Activates the cyclical sending. |
| Send cyclically every | 1 s – 6 h [5 min] | Period that elapses between two cyclic transmissions. |

| | | |
|-------------------------------|---|--|
| Behaviour on bus power return | <ul style="list-style-type: none"> • no action • send status | Setting whether the current status is to be sent after a reset. If "Cyclic sending" is active, the parameter is set to "send status". |
| Special function | <ul style="list-style-type: none"> ▪ not active ▪ additional object ▪ additional object inverted | Setting an additional special function. |
| Lock object | <ul style="list-style-type: none"> • not active • active | Setting whether lock object is active or not. |
| Behaviour at lock | <ul style="list-style-type: none"> • no action • contact closed • contact open | Defines the behaviour during an active lock. These settings are available when the parameter "Cyclic sending" is "not active." |
| Behaviour at lock | <ul style="list-style-type: none"> • no action, cyclic sending is not active • no action, cyclic sending is active • contact closed, cyclic sending is active • contact open, cyclic sending is active | Defines the behaviour during an active lock. These settings are available when the parameter "Cyclic sending" is "not active." |

Table 9: Settings – Send contact status

The following table shows the available communication objects:

| Number | Name/Object Function | Length | Usage |
|--------|--|--------|--|
| 0 | Input A – Zustand senden | 1 Bit | Switching function of the channel. |
| 2 | Input A Additional object – Send status | 1 Bit | Switching function for additional object. |
| 2 | Input A Additional object – Send status inverted | 1 Bit | Switching function for additional object inverted. |

Table 10: Communication objects – Send contact status

Value for „Contact closed“ / Value for „Contact open“

Here the value for a closed contact (rising edge) or opened contact (falling edge) is set. If, for example, the channel of a switching actuator is to be switched ON and OFF with one input, different values must be output for the rising and falling edges. Otherwise, a 0 signal (value for both: OFF) is sent twice in succession, for example.

Send delay:

If this is set to "active", the delay affects the previously described parameters "Value for Contact closed" and "Value for Contact open". Both values are therefore delayed. With the setting "active for contact closed", only the value assigned to the parameter "Value for contact closed" is delayed. If this is set to "ON", for example, only this value is sent with a delay. With the setting "active for contact open", only the value assigned to the parameter "Value for contact closed" is delayed.

Cyclic sending:

With this function, you can have the state of the input sent automatically periodically at certain intervals.

Behaviour at lock:

Depending on the setting for "Cyclic sending", there are two different selection options:

Cyclic sending → active

- **no action, cyclic sending is not active:** Nothing is sent during an active lock.
 - **no action, cyclic sending is active:** The state that the input had before the lock is sent cyclically, regardless of whether the state changes during the lock.
 - **contact closed, cyclic sending is active / contact opened, cyclic sending is active:** During an active lock, the set "Value for Contact closed" or "Value for Contact opened" is sent cyclically, regardless of the current status.
- Cyclic sending → not active
- **no action:** Nothing is sent during an active lock.
 - **contact closed** respectively **contact opened:** The set "Value for Contact closed" or "Value for Contact opened" is sent once during an active lock, regardless of the current status.

The following diagram describes the function "Send contact status". In this example, the input sends the value 0 for the rising edge and the value 1 for the falling edge. In addition, the diagram shows the link with a switching actuator that has been configured with a normal switching function:

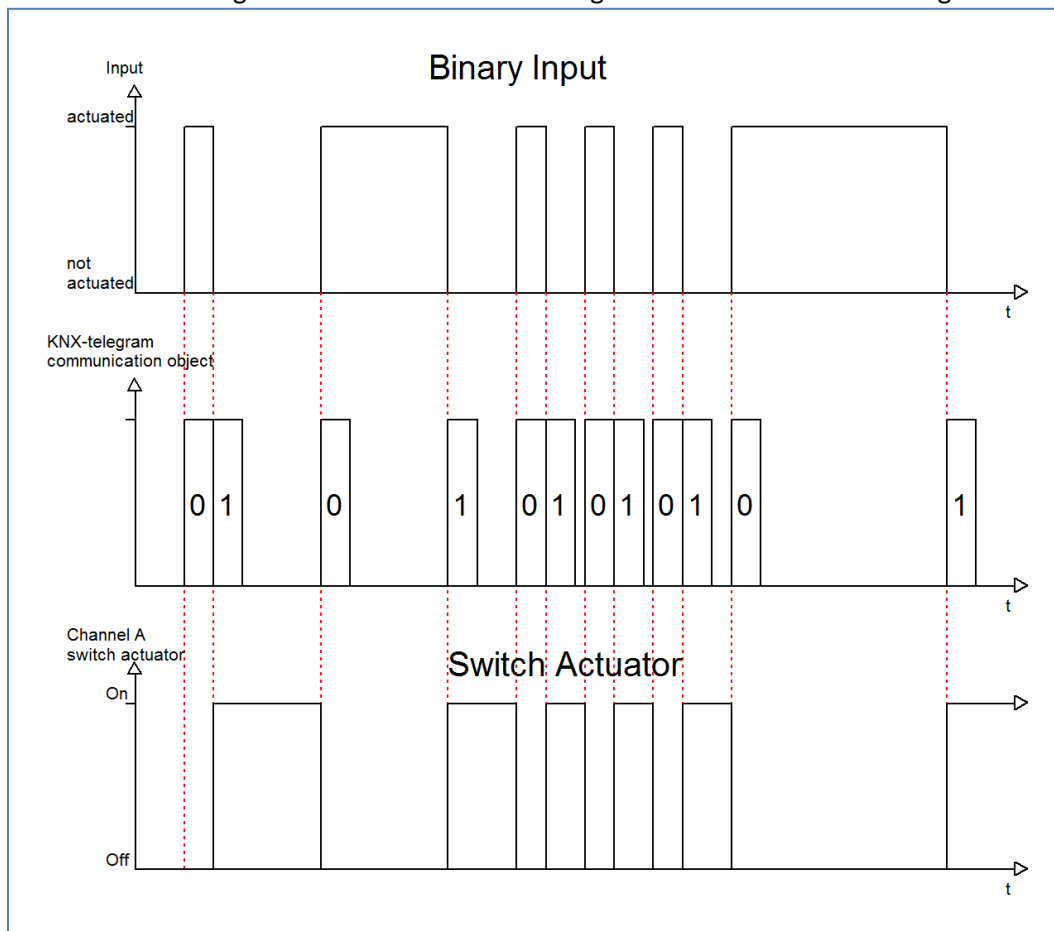

Figure 24: Diagram – Send contact status

The "Send delay" makes it possible for the binary input to send its state only after a configurable time has elapsed. With the sending delay for the value "On", this time starts to run down after switching on and with the sending delay for the value "Off", it only starts to run down after switching off. With this function, the current state of the input is always sent. If the state is changed again before the time has expired, e.g., in the case of the switch-on delay the input is switched off again before it has even been switched on, the delay expires.

The following diagram describes the send delay function for the value "On":

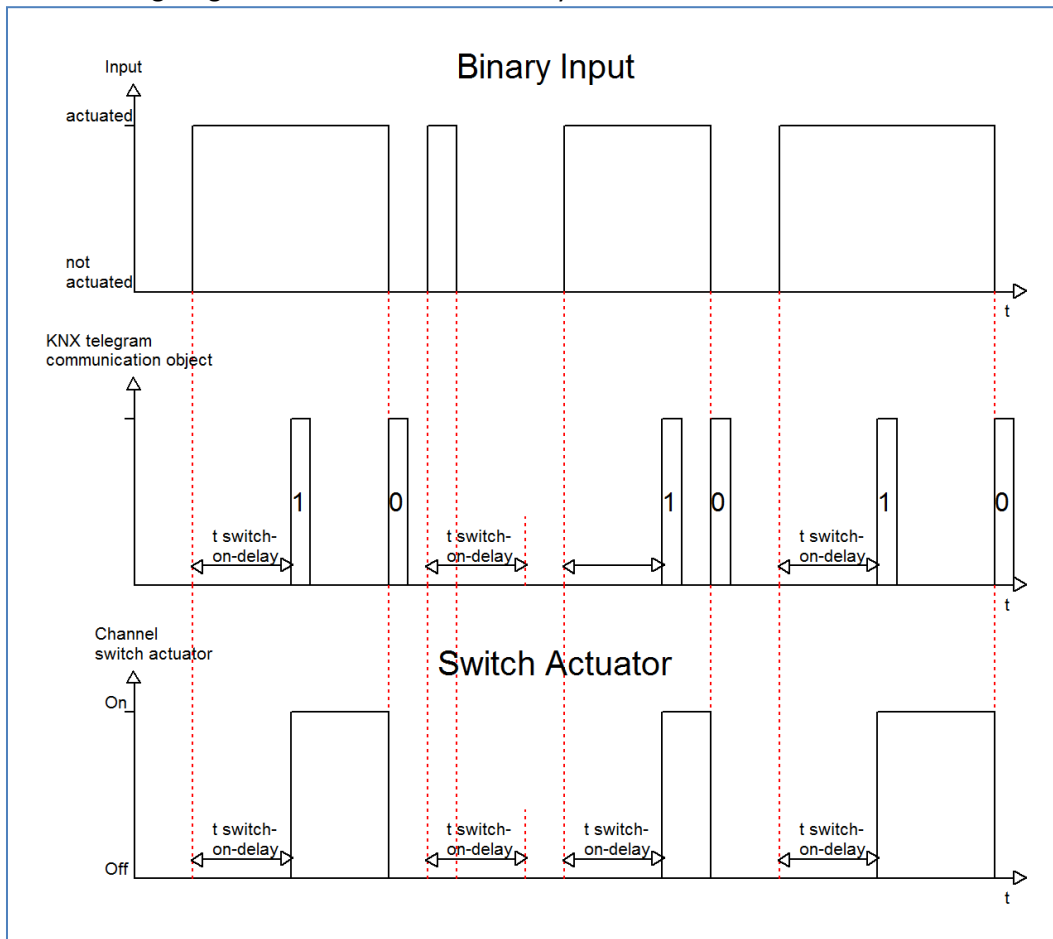

Figure 25: Diagram – Send delay

4.3.4 Send values

4.3.4.1 Subfunction: Send values

- Channels single
- Channels grouped

With this function, values of different data point types can be sent.
The following picture shows the available settings for grouped inputs:

| | |
|---------------------------------|---|
| Function of Inputs | send values |
| Subfunction | send values |
| Send value when | <input checked="" type="radio"/> closing <input type="radio"/> opening |
| Datapoint type | 1Byte DPT 5.001 Percent (0...100%) |
| Value 1st input | 0% |
| Value 2nd input | 0% |
| Special function | <input checked="" type="radio"/> innovative group control <input type="radio"/> additional object |
| innovative group control | |
| Group long keypress | <input type="radio"/> not active <input checked="" type="radio"/> active |
| Group long | send 1st and 2nd input |
| Group extra long keypress | <input checked="" type="radio"/> not active <input type="radio"/> active |
| Time for long keypress | basic setting |

Figure 26: Settings – Send values - Subfunction: Send values

The following table shows the available settings:

| ETS-Text | Dynamic range [Default value] | Comment |
|-----------------|--|---|
| Send value when | <ul style="list-style-type: none"> ▪ closing ▪ opening | Determines at which state the value is sent |
| Datapoint type | <ul style="list-style-type: none"> ▪ 1Bit DPT 1.001 Switch ▪ 2Bit DPT 2.001 Switch Control ▪ 1Byte DPT 5.001 Percent (0...100%) ▪ 1Byte DPT 5.005 Decimal factor (0...255) ▪ 1Byte DPT 17.001 Scene number ▪ 2Byte DPT 7.600 Colour Temperature (Kelvin) ▪ 2Byte DPT 9.001 Temperature (°C) ▪ 2Byte DPT 9.004 Brightness (Lux) ▪ 3Byte DPT 232.600 RGB Value 3x(0...255) | Setting the type of datapoint to be sent |

| | | |
|---|--|---|
| Value 1st/2nd input | any value according to set datapoint type | Only with grouped channels! Setting the action for the inputs. |
| Value | any value according to set datapoint type | Only with grouped channels! Setting the action for the input. |
| Special function | <ul style="list-style-type: none"> ▪ Innovative group control ▪ Additional object | Selection of the possible special function |
| Special function: Innovative Group control | | |
| Group long keypress | <ul style="list-style-type: none"> ▪ not active ▪ active | Activating a function with a long keystroke |
| Group long | <ul style="list-style-type: none"> ▪ send 1st and 2nd input ▪ send only 1st input ▪ send only 2nd input | Only with grouped channels! Setting which input reacts to the long keystroke |
| Group extra long keypress | <ul style="list-style-type: none"> ▪ not active ▪ active | Activating a function with an extra long keystroke |
| Group extra long | <ul style="list-style-type: none"> ▪ send 1st and 2nd input ▪ send only 1st input ▪ send only 2nd input | Only with grouped channels! Setting which input reacts to the extra long keystroke |
| Time for long keypress | Basic setting 0,1 s – 30,0 s | Setting of an individual time from when a long keystroke is detected. Basic setting refers to the time in "General settings". |
| Time for extra long keypress | 0,1 s – 30,0 s [2,0 s] | Setting of an individual time from when an extra long keystroke is detected |
| Special function: Additional object | | |
| Datapoint type (Additional object) | <ul style="list-style-type: none"> ▪ 1Bit DPT 1.001 Switch ▪ 2Bit DPT 2.001 Switch Control ▪ 1Byte DPT 5.001 Percent (0...100%) ▪ 1Byte DPT 5.005 Decimal factor (0...255) ▪ 1Byte DPT 17.001 Scene number ▪ 2Byte DPT 7.600 Colour Temperature (Kelvin) ▪ 2Byte DPT 9.001 Temperature (°C) ▪ 2Byte DPT 9.004 Brightness (Lux) ▪ 3Byte DPT 232.600 RGB Value 3x(0...255) | Setting the type of datapoint to be sent for the additional object.t |
| Value 1st/2nd input | any value according to set datapoint type | Only with grouped channels! Setting the action for the inputs. |
| Value | any value according to set datapoint type | Only with single channels! Setting the action for the input. |

Table 11: Settings – Send values - Subfunction: Send values

For details on innovative group control, see [4.3.2.1.1 Innovative group control](#)

The principle for "send values" is the same as for the "switch" function.

For details on "additional object", see [4.3.2.1.2 Additional object.](#)

With the "Send values" setting, a separate DTP can be assigned for the additional object.

"Additional object inverted" is not available with "Send values".

The following table shows the available communication objects:

| Number | Name/Object Function | Length | Usage |
|--------|---|--------|---|
| 0 | Input A Input A/B – Switch, Percent value ... | | Switching function of the input(s). DPT depending on the parameter setting |
| 2 | Input A Input A/B Group long – Switch, Percent value ... | | Switching function with long keystroke. DPT depending on the parameter setting. |
| 2 | Input A Input A/B Additional object – Switch, Percent value ... | | Switching function for additional object. DPT depending on the parameter setting. |
| 4 | Input A Input A/B Group extra long – Switch, Percent value ... | | Switching function with extra long keystroke. DPT depending on the parameter setting. |

Table 12: Communication objects – Send values - Subfunction: Send values

4.3.4.2 Subfunction: Toggle Values/Scenes (up to 4 Values)

- Channels single
- Channels grouped

This allows up to 4 different values of a data point type to be toggled.
The following picture shows the available settings for grouped inputs:

| | |
|------------------------------------|---|
| Function of Inputs | send values |
| Subfunction | toggle values/scenes (up to 4 values) |
| Send value when | <input checked="" type="radio"/> closing <input type="radio"/> opening |
| Assignment of the inputs | <input checked="" type="radio"/> next / previous <input type="radio"/> previous / next |
| Number of values | 2 |
| Datapoint type | 1Byte DPT 5.001 Percent (0...100%) |
| 1st Toggle value | 0% |
| 2nd Toggle value | 40% |
| Long keypress | <input type="radio"/> not active <input checked="" type="radio"/> active |
| 1st input: Action on long keypress | 1st Toggle value |
| 2nd input: Action on long keypress | 2nd Toggle value |
| Time for long keypress | basic setting |
| Switching type | <input checked="" type="radio"/> limit stop (after last value, this is repeated) <input type="radio"/> overrun (after last value, the first value is sent a... |

Figure 27: Settings – Send Values - Subfunction: Toggle values/scenes (up to 4 values)

The following table shows the available settings:

| ETS-Text | Dynamic range [Default value] | Comment |
|---|---|--|
| Send value when | <ul style="list-style-type: none"> ▪ closing ▪ opening | Determines at which state the value is sent |
| Assignment of the inputs | <ul style="list-style-type: none"> ▪ next / previous ▪ previous / next | Only for grouped channels! Setting in which direction to shift when actuating the inputs. |
| Number of values | <ul style="list-style-type: none"> ▪ 2 ▪ 3 ▪ 4 | Setting between how many values to be switched. |
| Datapoint type | <ul style="list-style-type: none"> ▪ 2Bit DPT 2.001 Switch Control ▪ 1Byte DPT 5.001 Percent (0...100%) ▪ 1Byte DPT 5.005 Decimal factor (0...255) ▪ 1Byte DPT 17.001 Scene number ▪ 2Byte DPT 7.600 Colour Temperature (Kelvin) ▪ 2Byte DPT 9.001 Temperature (°C) ▪ 2Byte DPT 9.004 Brightness (Lux) ▪ 3Byte DPT 232.600 RGB Value 3x(0...255) | Setting the type of data point to be sent |
| 1st - 4th Toggle value | any value according to set datapoint type | Setting the respective value for the toggle value |
| Long keypress | <ul style="list-style-type: none"> ▪ not active • active | Activating a function with a long keystroke |
| 1st/2nd input: Action on long keypress | <ul style="list-style-type: none"> • 1st-4th Toggle value • 4th Toggle value if last 1st Toggle value, otherwise 1st Toggle value • Send 0 • "Off" to second object • "On" to second object | Only for grouped channels! Setting the action with long keystroke |
| Action with a long keypress | <ul style="list-style-type: none"> • 1st-4th Toggle value • 4th Toggle value if last 1st Toggle value, otherwise 1st Toggle value • Send 0 • "Off" to second object • "On" to second object | Only for single channels! Setting the action with long keystroke |
| Time for long keypress | Basic setting 0,1 s – 30 s | Setting of a time from when a long keystroke is detected |
| Switching type | <ul style="list-style-type: none"> • Limit stop (after the last value, this is repeated) • Overrun (after the last value, the first value is sent again) | Only for grouped channels! Setting what should happen when the last switching value is reached |

Table 13: Settings – Send Values - Subfunction: Toggle values/scenes (up to 4 values)

Functional principle:

The Toggle Values/Scenes function can send up to 4 different values when a button is pressed shortly. The values are toggled one after the other. Depending on the set parameters, for example, when the button is pressed, the 2nd toggle value is transmitted if the 1st toggle value was previously transmitted and the 3rd toggle value if the 2nd toggle value was previously transmitted.

The parameter "**Long keypress**" can be used to transmit a fixed value for a long keypress in addition to the changeover by a short keypress.

If you select "**1st - 4th toggle value**", a fixed toggle value (value corresponding to the assigned toggle values) is always transmitted when a long key is pressed.

The setting "**4th toggle value if last 1st toggle value, otherwise 1st toggle value**" represents a toggle function which switches between the 1st and 4th toggle value. If the 1st toggle value was transmitted last, the 4th toggle value is transmitted; for every other value the 1st toggle value is transmitted.

The setting "**Send 0**" sends the value 0 to the switchover object. If, for example, the data point type is set to percentage, the value 0% is sent.

The setting "**On to second object**" or "**Off to second object**" displays another communication object for the long keypress. The fixed value On or Off is then transmitted to this 1-bit object.

With the setting "**Time delay between the toggle values**", the sending of the telegram is delayed by the set time after the key is pressed. If you press the key again during the delay time, the next toggle value is activated immediately, and the delay time is restarted. If, for example, you want to go directly from the first toggle value to the third toggle value without activating the second one - with a delay time of 2 seconds - press the key twice within 2 seconds.

Parameter "Switching type" (only available with grouped channels):

Limit stop: With the switching type limit stop, the 4th switching value is sent again after sending the 4th switching value.

Overrun: With the overrun switching type, the 1st switching value is sent again after the 4th switching value.

For the single button function, this parameter is permanently set to overrun.

The following table shows the available communication objects:

| Number | Name/Object Function | Length | Usage |
|--------|---|--------|--|
| 0 | Input A Input A/B – Forcible control, Percent value | | Sending the toggle value; DPT depending on the parameter setting. |
| 1 | Input A Input A/B – Status of percent value ... | | Receive status; DPT depending on parameter setting. |
| 2 | Input A long Input A/B long – Switch | 1 Bit | Switching function of the long button. Only appears when "On or Off to second object" is set. |

Table 14: Communication objects – Send Values - Subfunction: Toggle values/scenes (up to 4 values)

4.3.4.3 Subfunction: Shift Value

Channels grouped

With the function Send values - Shift values, values can be shifted up or down within the set limits.

The following figure shows the available settings:

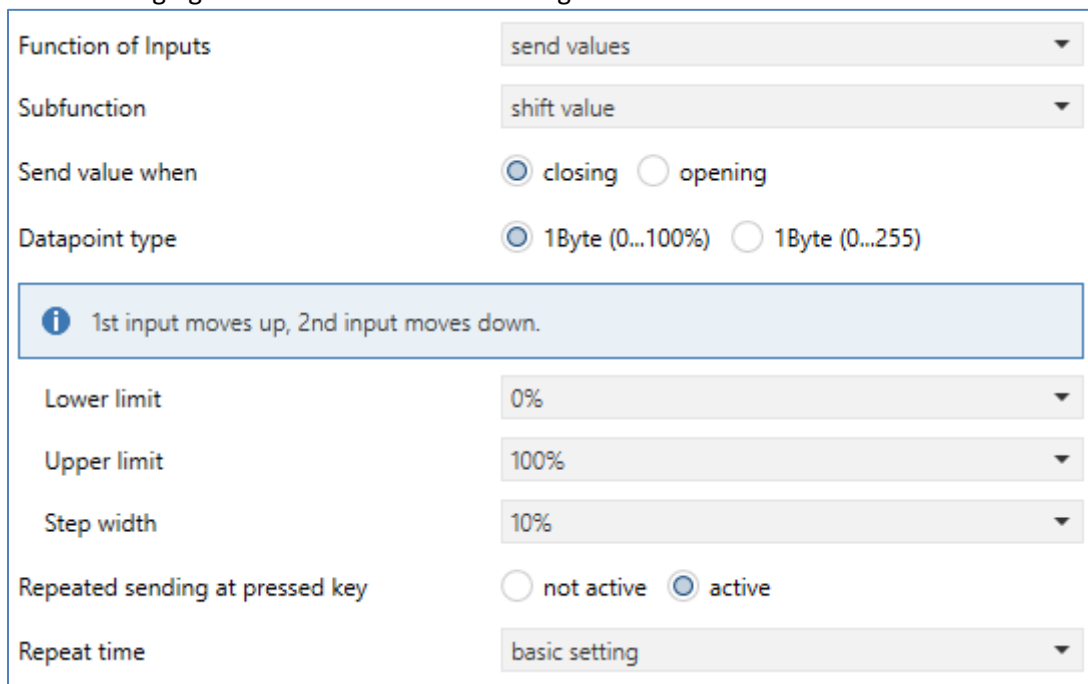

Figure 28: Settings – Send Values - Subfunction: Shift Values

Die nachfolgende Tabelle zeigt alle verfügbaren Einstellungen:

| ETS-Text | Dynamic range [Default value] | Comment |
|---------------------------------|---|--|
| Send value when | <ul style="list-style-type: none"> ▪ closing ▪ opening | Determines in which state the value is sent. |
| Datapoint type | <ul style="list-style-type: none"> ▪ 1 Byte (0...100%) ▪ 1 Byte (0...255) | Setting the datapoint type for the value shift. |
| Lower limit | 0 – 100% / 0 – 255 [0%/0] | Setting the lower limit value for the value shift. |
| Upper limit | 0 – 100% / 0 – 255 [100%/255] | Setting the upper limit value for the value shift. |
| Step width | 1 – 100% / 1 – 255 [10%/10] | Setting the step width between two sending commands. |
| Repeated sending at pressed key | <ul style="list-style-type: none"> ▪ not active ▪ active | Activating the transmission repetition while holding down the key. |
| Repeat time | basic setting 0,1 s – 30,0 s | Repetition time between two telegrams while the button is pressed. |

Table 15: Settings – Send Values - Subfunction: Shift Values

Functional principle:

The " Shift value" function shifts the set datapoint type within the set limits. When the "Down" key is pressed, the set step size is subtracted from the last value and when the "Up" key is pressed, the set step size is added to the last value.

Lower/Upper limit:

The value is shifted within these limits. The function never falls below the lower limit value and never exceeds the upper limit value.

Step Width:

The step width indicates the distance between two sent telegrams. If the value 10% was sent during the previous transmission, the value 20% is sent with the next "Up" command - with a set step size of 10%.

Repeated sending at pressed key:

Repeated sending while holding down the key allows the function to increase/decrease the value until the upper/lower limit is reached.

The following table shows the available communications objects:

| Number | Name/Object Function | Length | Usage |
|--------|---|--------|---|
| 0 | Input A/B – Percent value, Decimal value | 1 Byte | Send the value to be shifted; DPT depending on the parameter setting. |
| 3 | Input A/B – Status of percent value, decimal value | 1 Byte | Receive status; DPT depending on parameter setting. |

Table 16: Communication objects – Send Values - Subfunction: Shift Values

4.3.4.4 Subfunction: Send values by state

Channels single

With this function, when the contact is closed and when it is opened, a fixed value can be sent in each case according to the set data point type.

The following picture shows the available settings:

| | |
|-------------------------------|--|
| Function of Input | send values |
| Subfunction | send values by state |
| Datapoint type | 1Byte DPT 5.001 Percent (0...100%) |
| Value for "Contact closed" | 0% |
| Value for "Contact opened" | 0% |
| Send delay | active |
| Delay | 10 s |
| Cyclic sending | <input type="radio"/> not active <input checked="" type="radio"/> active |
| Send cyclically every | 5 min |
| Behaviour on bus power return | send status |

Figure 29: Settings – Send values - Subfunction: Send values by state

The following table shows the available settings:

| ETS-Text | Dynamic range [Default value] | Comment |
|-----------------------------------|---|--|
| Datapoint type | <ul style="list-style-type: none"> ▪ 2Bit DPT 2.001 Switch Control ▪ 1Byte DPT 5.001 Percent (0...100%) ▪ 1Byte DPT 5.005 Decimal factor (0...255) ▪ 1Byte DPT 17.001 Scene number ▪ 2Byte DPT 7.600 Colour Temperature (Kelvin) ▪ 2Byte DPT 9.001 Temperature (°C) ▪ 2Byte DPT 9.004 Brightness (Lux) ▪ 3Byte DPT 232.600 RGB Value 3x(0...255) | Setting the type of data point to be sent |
| Value for „Contact closed/opened“ | any value according to set datapoint type | Setting the respective value. |
| Send delay | <ul style="list-style-type: none"> • not active • active • active for „Contact closed“ • active für „Contact opened“ | Setting for a sending delay. |
| Delay | 1 s – 6 h [10 s] | Setting by which time the values are sent delayed. |

| | | |
|-------------------------------|---|---|
| Cyclic sending | <ul style="list-style-type: none"> • not active • active | Activates the cyclical sending. |
| Send cyclically every | 1 s – 6 h [5 min] | Period that elapses between two cyclic transmissions. |
| Behaviour on bus power return | <ul style="list-style-type: none"> • no action • send status | Setting whether the current status is to be sent after a reset. If "Cyclic sending" is active, the parameter is set to "send status". |

Table 17: Settings – Send values - Subfunction: Send values by state

The value to be sent can be set according to the set data point type for closing as well as for opening the contact.

The following table shows the available communication objects:

| Number | Name/Object Function | Length | Usage |
|--------|--|--------|---|
| 0 | Input A – Forcible control, Percent value ... | | Sending the toggle value; DPT depending on the parameter setting. |

Table 18: Communication objects – Send values - Subfunction: Send values by state

4.3.4.5 Subfunction: Multi-Tip Function (Send values after number of operations)

Channels single

The multi-tip function can send a fixed set value according to the set data point type depending on how many times the key is pressed in succession.

Note: A fast response time is recommended for this function.

The following picture shows the available settings:

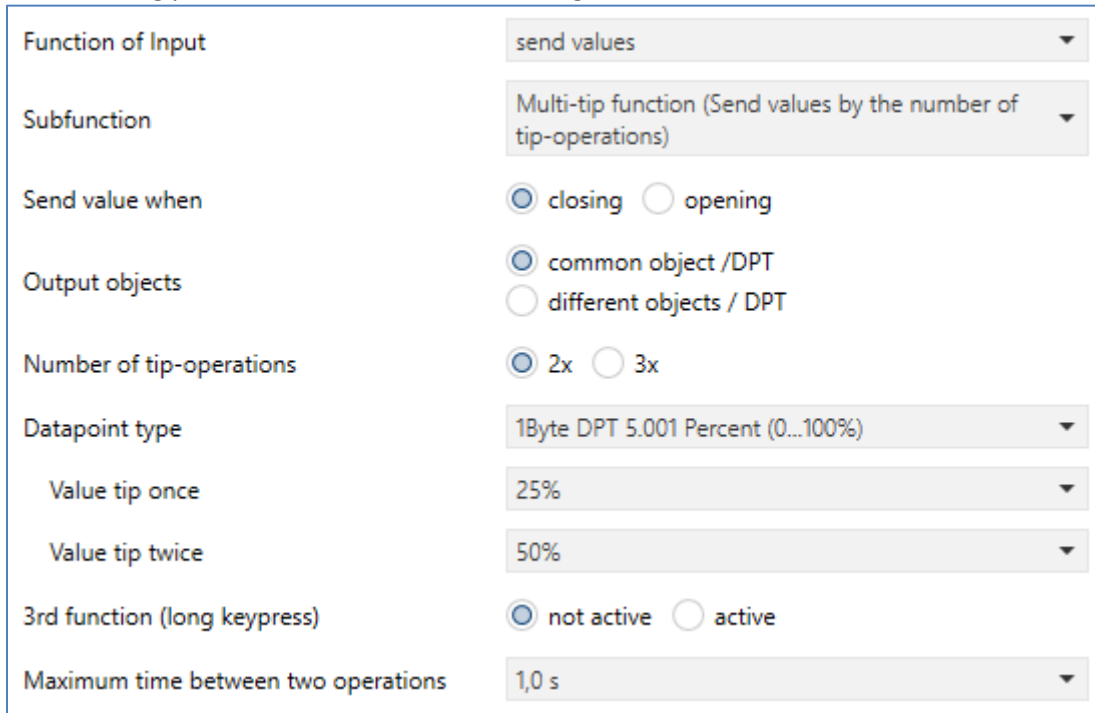

Figure 30: Settings – Send values - Subfunction: Multi-tip function

Die nachfolgende Tabelle zeigt alle verfügbaren Einstellungen:

| ETS-Text | Dynamic range [Default value] | Comment |
|--------------------------|--|---|
| Send value when | <ul style="list-style-type: none"> ▪ closing ▪ opening | Determines in which state the value is sent. |
| Output objects | <ul style="list-style-type: none"> ▪ common object / DPT ▪ different objects / DPT | Setting whether one DPT or different DPTs are used. |
| Number of tip-operations | <ul style="list-style-type: none"> ▪ 2x ▪ 3x | Settings of the possible tip-functions |
| Datapoint type | <ul style="list-style-type: none"> ▪ 1Bit DPT 1.001 Switch ▪ 2Bit DPT 2.001 Switch Control ▪ 1Byte DPT 5.001 Percent (0...100%) ▪ 1Byte DPT 5.005 Decimal factor (0...255) ▪ 1Byte DPT 17.001 Scene number ▪ 2Byte DPT 7.600 Colour Temperature (Kelvin) ▪ 2Byte DPT 9.001 Temperature (°C) ▪ 2Byte DPT 9.004 Brightness (Lux) ▪ 3Byte DPT 232.600 RGB Value 3x(0...255) | Set the data point type for the value to be sent. Available for selection: only one datapoint type if “Common object/DPT” or: Datapoint type 1x/2x/3x pressed if “Different objects/DPT” |

| | | |
|-------------------------------------|--|--|
| Value tip once/twice/triple | any value according to set datapoint type | Setting the respective value for the switching value |
| 3./4. Function (long keypress) | <ul style="list-style-type: none"> ▪ not active ▪ active | Setting an additional function with a long keypress |
| Datapoint type for long keypress | <ul style="list-style-type: none"> ▪ 1Bit DPT 1.001 Switch ▪ 2Bit DPT 2.001 Switch Control ▪ 1Byte DPT 5.001 Percent (0...100%) ▪ 1Byte DPT 5.005 Decimal factor (0...255) ▪ 1Byte DPT 17.001 Scene number ▪ 2Byte DPT 7.600 Colour Temperature (Kelvin) ▪ 2Byte DPT 9.001 Temperature (°C) ▪ 2Byte DPT 9.004 Brightness (Lux) ▪ 3Byte DPT 232.600 RGB Value 3x(0...255) | Setting the action for a long keystroke |
| Value for long keypress | any value according to set datapoint type | Setting the respective value for the toggle value |
| Time for long keypress | Basic setting 0,1 s – 30,0 s | Setting from when a long keystroke is detected |
| Maximum time between two operations | 0,1 s – 30 s [0,5 s] | Setting an individual time between two button operations |

Table 19: Settings – Send values - Subfunction: Multi-tip function

The value to be sent can be set according to the set data point type.

The following table shows the available communication objects:

| Number | Name/Object Function | Length | Usage |
|--------|----------------------|--------|--|
| 0 | Input A tip: | | Sending the tip value if common object/DPT . DPT depending on the parameter setting |
| 0 | Input A, tip once: | | Sending the tip value when different objects/DPT . DPT depending on the parameter setting and number of operations. |
| 1 | Input A, tip twice: | | |
| 2 | Input A, tip triple: | | |
| 3 | Input A long: | | Transmission of the value for long keystroke; DPT depending on the parameter setting |

Table 20: Communication objects – Send values - Subfunction: Multi-tip function

4.3.5 Switch/send value short/long (with 2 objects)

- Channels single
- Channels grouped

With the function "switch/send values short/long (with 2 objects)", 2 different values can be sent for the short and long button. The short and the long button have different objects, whereby it is also possible to send out different data point types.

The following figure shows the available settings (here for grouped inputs):

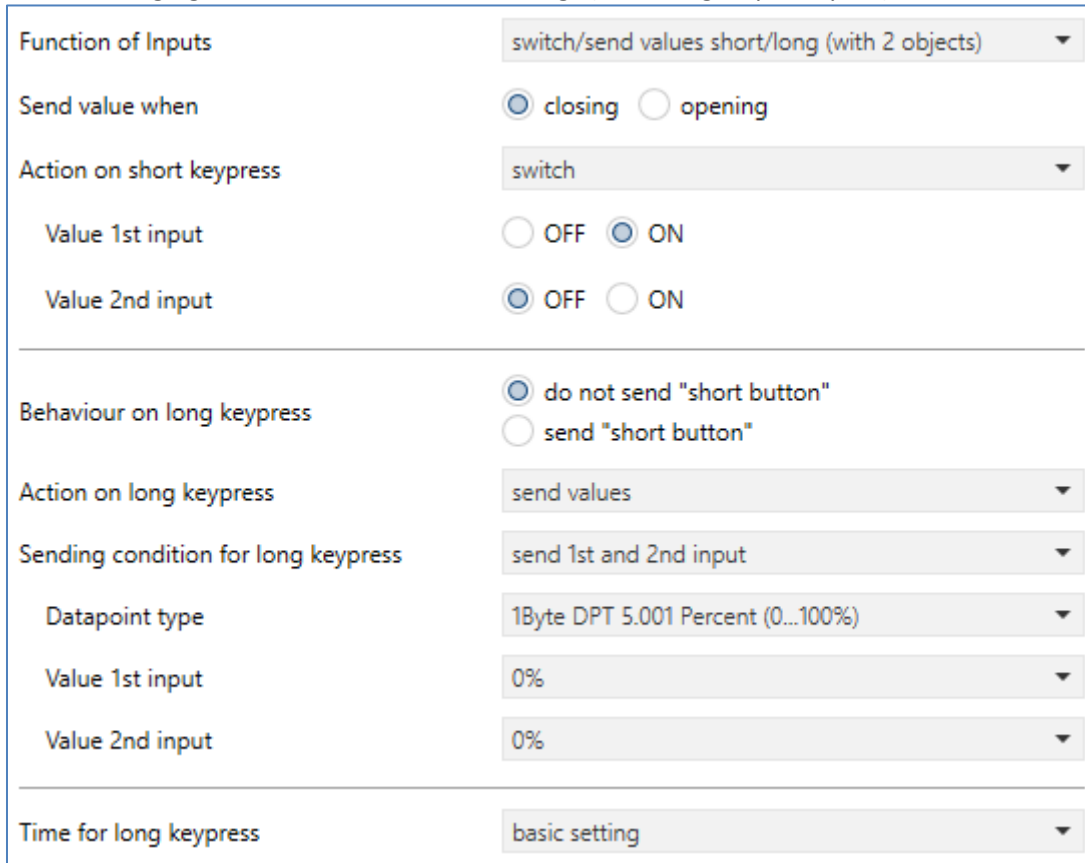

Figure 31: Settings – Switch/send value short/long (with 2 objects)

The following table shows all available settings:

| ETS-Text | Dynamic range [Default value] | Comment |
|-------------------------------|--|---|
| Send value when | <ul style="list-style-type: none"> ▪ closing ▪ opening | Determines in which state the value is sent. |
| Action on short/long keypress | <ul style="list-style-type: none"> ▪ switch ▪ switch Off ▪ switch On ▪ toggle ▪ send values ▪ not active | Setting the function for the short/long key. "Switch On/Off" only with single-button function. "Switch" only with two-button function |

| | | |
|-------------------------------------|---|---|
| Datapoint type | <ul style="list-style-type: none"> ▪ 2Bit DPT 2.001 Switch Control ▪ 1Byte DPT 5.001 Percent (0...100%) ▪ 1Byte DPT 5.005 Decimal factor (0...255) ▪ 1Byte DPT 17.001 Scene number ▪ 2Byte DPT 7.600 Colour Temperature (Kelvin) ▪ 2Byte DPT 9.001 Temperature (°C) ▪ 2Byte DPT 9.004 Brightness (Lux) ▪ 3Byte DPT 232.600 RGB Value 3x(0...255) | Setting the datapoint type for the value to be sent Setting only available if "Action short/long keypress" is set to "Send values". |
| Value | any value according to set datapoint type | Only for single channels! Setting the respective value on operation. |
| Value 1st/2nd Input | any value according to set datapoint type | Only for grouped channels! Setting the respective value on operation. |
| Behaviour on long keypress | <ul style="list-style-type: none"> ▪ Do not send "short button" ▪ Send "short button" | Setting whether the value for the short button is also transmitted when the long button is pressed. |
| Sending condition for long keypress | <ul style="list-style-type: none"> ▪ send 1st and 2nd input ▪ send only 1st input ▪ send only 2nd input | Only for grouped channels! Setting the sending condition for the long button. |
| Time for long keypress | Basic setting 0,1 s – 30,0 s | Setting from when a long keypress is detected. |

Table 21: Settings – Switch/send values short/long (with 2 objects)

Functional principle:

For grouped channels, different values can be sent for each of the two inputs (for the short as well as for the long button). For single channels, only one value can be sent for the short as well as for the long button. The data point type can be set separately for the short and the long keystroke.

The following table shows the available communication objects:

| Number | Name/Object Function | Length | Usage |
|--------|--|--------|--|
| 0 | Input A short: Input A/B short – Switch, percent value ... | | Sending the value for the short button. DPT depending on the parameter setting. |
| 1 | Input A short: Input A/B short – Status for toggle | 1 Bit | Receiving the status for short button. Only for function "Toggle" |
| 2 | Input A long: Input A/B long – Switch, percent value ... | | Sending the value for the long button. DPT depending on the parameter setting. |
| 3 | Input A long: Input A/B long – Status for toggle | 1 Bit | Receiving the status for long button. Only for function "Toggle" |

Table 22: Communication objects – Switch/send values short/long (with 2 objects)

4.3.6 Scene

Channels single

The scene function makes it possible to call up and save scenes that cover all trades. If the saving function is activated, it can be executed by a long keystroke.

The following image shows the available settings:

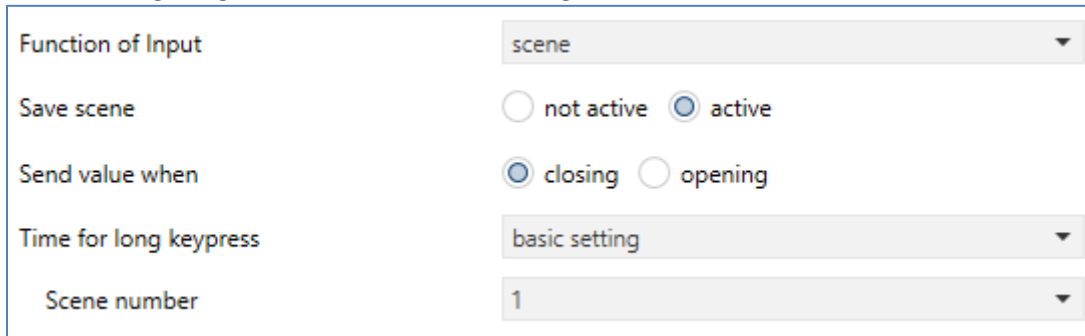

Figure 32: Settings – Scene

The following table shows the available settings:

| ETS-Text | Dynamic range [Default value] | Comment |
|------------------------|---|---|
| Save scene | <ul style="list-style-type: none"> ▪ not active ▪ active | Release of saving the scenes. The saving is carried out by a long keystroke. |
| Send value when | <ul style="list-style-type: none"> ▪ closing ▪ opening | Determines in which state the scene is to be sent. |
| Time for long keypress | basic setting 0,1 s – 30,0 s | Only visible if "Save scene" is active. Setting the time for the long keypress to save a scene. |
| Scene number | 1 – 64 [1] | Setting the respective scene number. |

Table 23: Settings – Scene

To call a scene or store a new value for the scene, the corresponding code is sent to the corresponding communication object for the scene:

| Scene | Call | | Save | |
|-------|------|------|------|------|
| | Hex. | Dec. | Hex. | . |
| 1 | 0x00 | 0 | 0x80 | 128 |
| 2 | 0x01 | 1 | 0x81 | 129 |
| 3 | 0x02 | 2 | 0x82 | 130 |
| 4 | 0x03 | 3 | 0x83 | 131 |
| 5 | 0x04 | 4 | 0x84 | 132 |
| 6 | 0x05 | 5 | 0x85 | 133 |
| 7 | 0x06 | 6 | 0x86 | 134 |
| 8 | 0x07 | 7 | 0x87 | 135 |
| 9 | 0x08 | 8 | 0x88 | 136 |
| 10 | 0x09 | 9 | 0x89 | 137 |
| 11 | 0x0A | 10 | 0x8A | 138 |
| 12 | 0x0B | 11 | 0x8B | 139 |
| 13 | 0x0C | 12 | 0x8C | 140 |
| 14 | 0x0D | 13 | 0x8D | 141 |
| 15 | 0x0E | 14 | 0x8E | 142 |
| 16 | 0x0F | 15 | 0x8F | 143 |
| 17 | 0x10 | 16 | 0x90 | 144 |
| 18 | 0x11 | 17 | 0x91 | 145 |
| 19 | 0x12 | 18 | 0x92 | 146 |
| 20 | 0x13 | 19 | 0x93 | 147 |
| 21 | 0x14 | 20 | 0x94 | 148 |
| 22 | 0x15 | 21 | 0x95 | 149 |
| 23 | 0x16 | 22 | 0x96 | 150 |
| 24 | 0x17 | 23 | 0x97 | 151 |
| 25 | 0x18 | 24 | 0x98 | 152 |
| 26 | 0x19 | 25 | 0x99 | 153 |
| 27 | 0x1A | 26 | 0x9A | 154 |
| 28 | 0x1B | 27 | 0x9B | 155 |
| 29 | 0x1C | 28 | 0x9C | 156 |
| 30 | 0x1D | 29 | 0x9D | 157 |
| 31 | 0x1E | 30 | 0x9E | 158 |
| 32 | 0x1F | 31 | 0x9F | 159 |
| | | | | |
| 64 | 0x3f | 63 | 0xBF | 191 |

Table 24: Scene call and save

The following table shows the available communication object:

| Number | Name/Object Function | Length | Usage |
|--------|----------------------|--------|--------------------------|
| 2 | Input A – Scene | 1 Byte | Call up/saving of scenes |

Table 25: Communication object – Scene

4.3.7 Blinds/Shutter

- Channels single
- Channels grouped

The following figure shows the available settings (here: grouped channels):

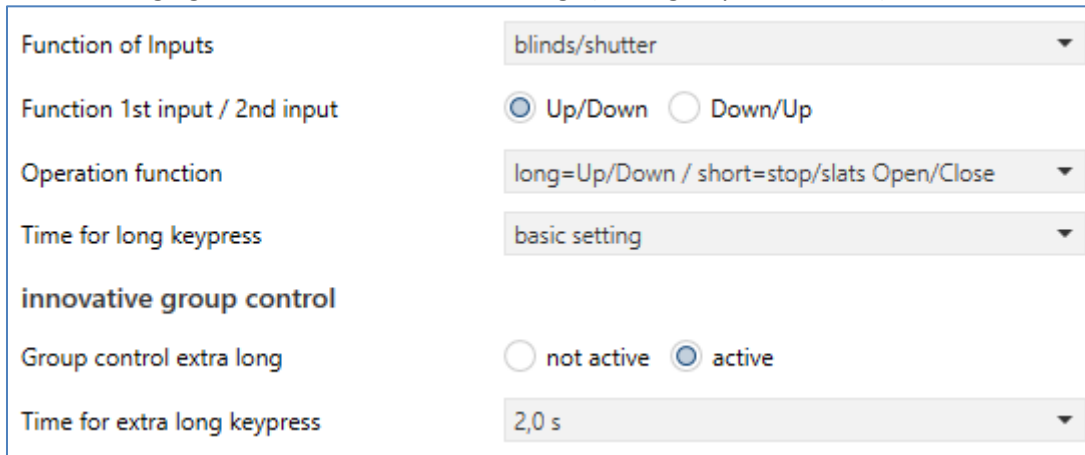

Figure 33: Settings – Blinds/Shutter

The following table shows the available settings:

| ETS-Text | Dynamic range [Default value] | Comment |
|---|---|--|
| Function 1st input /2nd input | <ul style="list-style-type: none"> ▪ Up/Down ▪ Down/Up | Only with grouped channels! Setting the input assignment for the Up and Down function |
| Operation function | <ul style="list-style-type: none"> ▪ Long=Up/Down (or “move”)/ Short=Stop/slats Open/Close ▪ Short=Up/Down (or “move”) / Long=Stop/slats Open/Close ▪ Short=Up/Down/Stop (MDT Single Object Control) ▪ Short=Up/Down/Stop / Long=Central object (MDT Single Object Control) ▪ pressed=Up/Down / released=Stop | Setting the concept of how to operate with long/short buttons. Functions with "MDT Single Object Control" and "pressed/released" only available with grouped channels! |
| Time for long keypress | Basic setting 0,1 s – 30,0 s | Setting of an individual time from when a long keystroke is detected |
| Innovative Group control (Only possible with concept „Up/Down (or “move”)/ Short=Stop/slats Open/Close“) | | |
| Group control extra long | <ul style="list-style-type: none"> ▪ not active ▪ active | Activation of a further function with extra long keystroke |
| Time for extra-long keypress | 0,1 s – 30 s [2,0 s] | Setting of an individual time from when an extra long keystroke is detected |

Table 26: Settings – Blinds/Shutter

Two communication objects are displayed for the "blind" function: the object "Stop/slat open/close" and the object "blinds up/down ".The moving object is used to move the blinds/shutters up and down. The stop/step object is used to adjust the slats. In addition, this function stops the up/down movement as far as the end position has not yet been reached.

With the function for grouped channels, the assignment can be set, the correlations are shown in the following table:

| Input | Function Up/Down | | Function Up/Down | |
|-------------------------|------------------|------------------|------------------|-----------------|
| | Input A | Input B | Input B | Input A |
| Moving object | Up | Down | Down | Up |
| Stop/Step object | Stop/slats open | Stop/slats close | Stop/slats close | Stop/slats open |

Table 27: Functional principle – blind for grouped channels

The single channel function is used to toggle between the up and down movement after each keystroke.

As blind actuators always use a 1 signal for down movement and a 0 signal for up movement, the push-button also outputs this signal.

It is also possible to swap the action for the long and short push-button action. Thus, it is possible to select whether a long or a short keystroke is to be used. The stop/step object then adopts the other operating concept.

MDT Single Object Control

Channels grouped

MDT Single Object Control enables a new operating concept for controlling roller shutters. For use, the following parameter must be set to active in the **MDT Shutter Actuator** to be controlled:

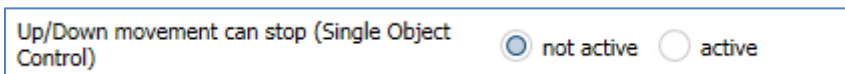

Now it is possible to start the up/down movement with a short keystroke and to stop an active up/down movement with a short keystroke.

With the setting "Short = Up/Down/Stop / Long = Central object (MDT Single Object Control)" an additional object is displayed, which can start the up/down movement with a long keystroke and can also stop an active up/down movement with a long keystroke. This function can be used, for example, to move a single shutter in a room with a short keystroke and to move the entire room with a long keystroke.

Operating function „pressed=Up/Down / released=Stop“

Channels grouped

This makes it possible for the blind to move only if the button is pressed. When the button is released, a stop command is automatically sent and the blind stops.

This operating function is adapted to the principle of a "dead man's switch".

Innovative Group control (Group control extra long)

Channels single

Channels grouped

If the key is pressed extra long, the single blind starts moving after 0.5 s.

After another 1.5 s, the group starts with the same movement.

This activates the group function:

If Stop is then pressed briefly, all blinds stop. If the slat is adjusted with "short", the group also adjusts the slat.

After approx. 90 s the group function is deactivated again internally, and a Stop only affects the individual channel.

The following table shows the available communication objects:

| Number | Name/Object Function | Length | Usage |
|--------|---|--------|--|
| 0 | Input A: Input A/B: – Blinds Up/Down | 1 Bit | Up/down command for the shutter actuator |
| 0 | Input A/B short: – Shutter Up/Down/Stop | 1 Bit | MDT Single Object Control. Central object for up/down/stop function. Only with grouped channels and for roller shutters. |
| 1 | Input A: Input A/B:– Stop/Slats Open/Close | 1 Bit | Open/close slats; stop command. |
| 1 | Input A/B long: – Central Shutter Up/Down/Stop | 1 Bit | MDT Single Object Control. Central object for up/down/stop function. Only with grouped channels and for roller shutters. |
| 2 | Input A: – Status for change of direction | 1 Bit | Only with single channels. Receipt of the status with current information about the direction of the blind actuator. |
| 3 | Input A Group extra long: Input A/B Group extra long: Blinds Up/Down | 1 Bit | Receive the status of the current blind/roller shutter position. |
| 4 | Input A Group extra long: Input A/B Group extra long: Stop/Slats Open/Close | 1 Bit | Up/down command for the shutter actuator. |

Table 28: Communication objects – Blinds/Shutter

4.3.8 Dimming

- Channels single
- Channels grouped

The dimming function can be used to control dimming actuators.

The following figure shows the available settings (here: for grouped channels):

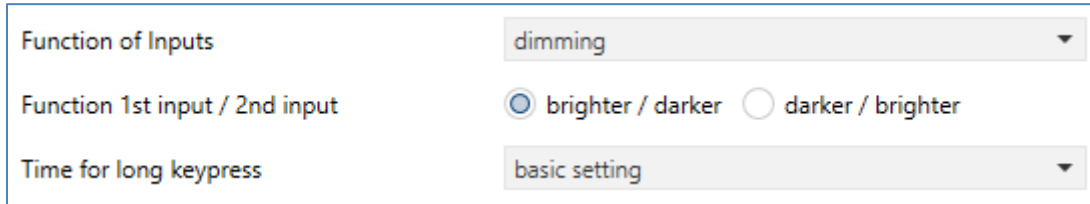

Figure 34: Setting – Dimming

The following table shows the available settings:

| ETS-Text | Dynamic range [Default value] | Comment |
|------------------------|---|---|
| Function 1st/2nd input | <ul style="list-style-type: none"> ▪ brighter/darker ▪ darker/brighter | Only with grouped channels. Setting the key assignment for the direction (brighter/darker). |
| Time for long keypress | Basic setting 0,1 s – 30,0 s | Setting an individual time from when a long key press is detected. |

Table 29: Setting – Dimming

If an input is configured as a dimming function, two communication objects appear for this input. Firstly, the function for a short button action, the "Dimming On/Off" switch object, and secondly the function for a long button action, the dimming object "Dimming relative".

The "dimming" function for grouped inputs can be set either as brighter/darker or as darker/brighter. The relationships are shown in the following table:

| | Function brighter/darker | | Function darker/brighter | |
|---------------------------|--------------------------|---------|--------------------------|----------|
| | Input 1 | Input 2 | Input 1 | Input 2 |
| Dimming function | brighter | darker | darker | brighter |
| Switching function | ON | OFF | OFF | ON |

Table 30: Functional principle – Dimming with grouped channels

With single channel dimming, the direction (brighter/darker) is reversed depending on the "Status for toggle" object.

The dimming function is a start-stop dimming, i.e. as soon as the dimming function becomes active, the input sends a "brighter or darker" command until the button is released. After the button is released, a stop telegram is sent, which ends the dimming process.

The following table shows the available communication objects:

| Number | Name/Object Function | Length | Usage |
|--------|---|--------|--|
| 0 | Input A: Input A/B – Dimming On/Off | 1 Bit | Switching command for the dimming function |
| 1 | Input A: Input A/B: – Dimming relative | 4 Bit | Command for relative dimming |
| 2 | Input A: – Status for toggle | 1 Bit | Only for single channels. Receipt of the status with current information about the status of the actuator to be controlled |

Table 31: Communication objects – Dimming

4.3.9 Counter

Channels single

With the "counter" function, pulse telegrams (divisor), a simple counter for different data point types or a consumption counter for different measured variables can be realised. The pulse and switching counter is suitable for 30 ms S0 pulses.

The following picture shows the available settings (here: Consumption counter => Power):

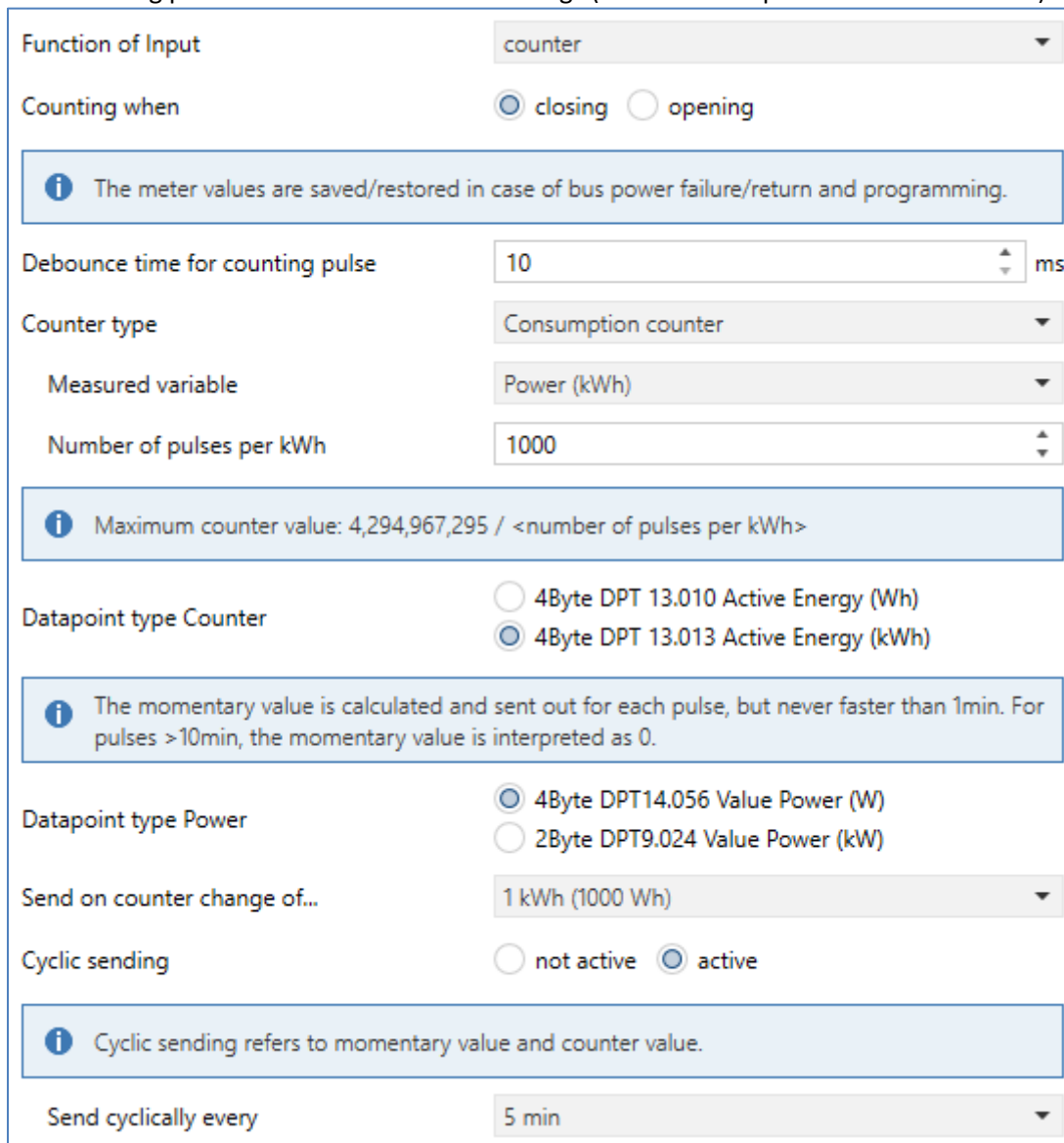

The screenshot shows a configuration window for a counter. The 'Function of Input' is set to 'counter'. Under 'Counting when', 'closing' is selected. A note states: 'The meter values are saved/restored in case of bus power failure/return and programming.' The 'Debounce time for counting pulse' is set to 10 ms. The 'Counter type' is 'Consumption counter', and the 'Measured variable' is 'Power (kWh)'. The 'Number of pulses per kWh' is set to 1000. A note indicates: 'Maximum counter value: 4,294,967,295 / <number of pulses per kWh>'. Under 'Datapoint type Counter', '4Byte DPT 13.013 Active Energy (kWh)' is selected. A note states: 'The momentary value is calculated and sent out for each pulse, but never faster than 1min. For pulses >10min, the momentary value is interpreted as 0.' Under 'Datapoint type Power', '4Byte DPT14.056 Value Power (W)' is selected. 'Send on counter change of...' is set to '1 kWh (1000 Wh)'. Under 'Cyclic sending', 'active' is selected. A note states: 'Cyclic sending refers to momentary value and counter value.' Finally, 'Send cyclically every' is set to '5 min'.

Figure 35: Settings – Counter

Die nachfolgende Tabelle zeigt die verfügbaren Einstellungen:

| ETS-Text | Dynamic range [Default value] | Comment |
|---|---|---|
| Counting when | <ul style="list-style-type: none"> ▪ closing ▪ opening | Determines in which state counting takes place. |
| Debounce time for counting pulse | 10 – 150 ms [10 ms] | With this time the inputs are debounced. |
| Counter type | <ul style="list-style-type: none"> • Pulse telegram (Divisor) • Simple counter • Energy counter | Determination of the meter type according to which the counter operates. |
| Counter type: Pulse telegram (Divisor) | | |
| Send ON every | 1 – 65535 Pulses [100] | Setting the interval at which an ON telegram is sent. |
| Counter type: Simple counter | | |
| Datapoint type Counter | <ul style="list-style-type: none"> ▪ 1Bit DPT1.001 Switch ▪ 1Byte DPT5.005 Decimal factor ▪ 2Byte DPT7.* (Unsigned value) ▪ 2Byte DPT8.* (Signed value) ▪ 2Byte DPT9.* (Float value) ▪ 4Byte DPT12.* (Unsigned value) ▪ 4Byte DPT13.* (Signed value) ▪ 4Byte DPT14.* (Float value) | Setting the data point type of the counter. |
| Send value every | 1 – 65535 Pulses [100] | Setting the interval at which transmission takes place. |
| Threshold value = „ON“ if more then | 1 – 50000 Pulses [1000] | Only available with setting "1Bit DPT1.001 Switch". Setting of a threshold from which number of pulses an "ON" telegram is sent. Before that always "OFF". After reaching the threshold, the input should be reset! |
| Send object every | 1 – 65535 Pulses [100] | Only available with setting "1Bit DPT1.001 Switch". Setting in which pulse interval the object is to be sent. |
| Counter type: Consumption counter | | |
| Measured variable | <ul style="list-style-type: none"> • Power (kWh) • Water / Gas (m³) • Individual | Determination of the measurand to be used for counting. |
| Measured variable: Power (kWh) | | |
| Number of pulses per kWh | 1 – 10000 [1000] | Number of pulses to count up 1 kWh. |
| Datapoint type Counter | <ul style="list-style-type: none"> • 4Byte DPT13.010 Active Energy (Wh) • 4Byte DPT13.013 Active Energy (kWh) | Adjustable datapoint type for the counter. |

| | | |
|---|---|--|
| Datapoint type Power | <ul style="list-style-type: none"> • 4Byte DPT14.056 Value Power (W) • 2Byte DPT9.024 Value Power (kWh) | Selecting the unit for the power. |
| Send on counter change of... | <ul style="list-style-type: none"> • 1 Wh • 10 Wh • 100 Wh • 1 kWh (1000Wh) | Setting for which change is to be sent. |
| Measured variable: Water / Gas (m³) | | |
| Number of pulses per m ³ | 1 – 10000 [1000] | Number of pulses to count up 1 m ³ . |
| Datapoint type Counter | <ul style="list-style-type: none"> • 4Byte DPT12.1200 Volume Liquid (Litre) • 4Byte DPT12.1201 Volume (Gas) (m³) • 4Byte DPT14.076 Value Volume (m³) | Adjustable datapoint type for the counter. |
| Send on counter change of... | <ul style="list-style-type: none"> • 0,001 m³ (1 Litre) • 0,01 m³ (10 Litre) • 0,1 m³ (100 Litre) • 1 m³ (1000 Litre) | Setting for which change is to be sent. Special features, see "Notes" below... |
| Datapoint type Flow | <ul style="list-style-type: none"> • 2Byte DPT9.025 Value Volume Flow (l/h) • 4Byte DPT13.002 Flow Rate (m³/h) • 4Byte DPT14.077 Value Volume Flux (m³/s) • 4Byte DPT14.1200 Volume Flux Meter (m³/h) | Adjustable data point type for flow. |
| Measured variable: Individual | | |
| Individual Measured variable (Unit) | Free text input | Input up to 30 bytes allowed |
| Number of pulses per Unit | 1 – 100000 [1000] | Number of pulses to count up 1 unit. |
| Datapoint type Counter | <ul style="list-style-type: none"> ▪ 1Byte DPT5.005 Decimal factor ▪ 2Byte DPT7.* (Unsigned value) ▪ 2Byte DPT8.* (Signed value) ▪ 2Byte DPT9.* (Float value) ▪ 4Byte DPT12.* (Unsigned value) ▪ 4Byte DPT13.* (Signed value) ▪ 4Byte DPT14.* (Float value) | Adjustable datapoint type for the counter. |
| Multiplier Counter | 1 ... 50000 [1] | Scaling of the internal counter to the output object. |
| Divisor Counter | 1 ... 50000 [1] | |
| Datapoint type Momentary value | <ul style="list-style-type: none"> ▪ 1Byte DPT5.005 Decimal factor ▪ 2Byte DPT7.* (Unsigned value) ▪ 2Byte DPT8.* (Signed value) ▪ 2Byte DPT9.* (Float value) ▪ 4Byte DPT12.* (Unsigned value) ▪ 4Byte DPT13.* (Signed value) ▪ 4Byte DPT14.* (Float value) | Adjustable datapoint type for the momentary value. |

| | | |
|--------------------------------|--|--|
| Multiplier current consumption | 1 ... 50000 [1] | Scaling of the internal consumption per hour to the output object. |
| Divisor current consumption | 1 ... 50000 [1] | |
| Send value every | 1 – 65535 Pulses [100] | Setting at which interval to send. |
| Valid for all settings | | |
| Cyclic sending | <ul style="list-style-type: none"> ▪ not active ▪ active | Setting whether values are to be sent cyclically. |
| Send cyclically every | 1 s – 6 h [5 min] | Distance between 2 cyclically sent telegrams |

Table 32: Settings – Counter

Counting when

Here it is determined whether a pulse is counted when the contact is opened or when it is closed.

Debounce time for counting pulse

The adjustment function is used to debounce the signal from mechanical switches.

Counter types

A distinction can be made between three types of meters. These are described as follows:

Pulse telegram (Divisor)

1Bit touch/switch pulses at the input are detected and counted. According to the setting "Send ON every X pulses", an "ON" telegram is sent on the bus.

Simple counter

With "DTP 1Bit Switching", a simple threshold value is sent here. If, for example, "Threshold = "ON" if more than" is set to 1000 pulses, the object sends an "OFF" to the bus until the 1000 pulses are reached. From that point on, an "ON" is sent.

The setting "Send object every" defines the intervals at which the object is sent. It is recommended to reset the counter after exceeding the threshold via object, otherwise only ON telegrams would be sent. After a reset, the counter starts again at "0". For all other data point types, the current counter reading is sent at intervals of the number of pulses defined under "Send value every".

Consumption counter

The consumption can be counted here according to the set measured variable (output in kWh, Gas/Water in m³ as well as an individual measured variable). A variety of datapoint types are available for the meters, the power, and the flow. Furthermore, the number of pulses per unit as well as the transmission frequency can be defined for each measured variable via the setting "Send on counter change of". In the individual setting, a measured variable with the corresponding unit can be freely selected. Different datapoint types are available for counter and momentary value as well as current consumption.

Due to the measured pulses, the reaction time of the flow rate is 1 - 10 minutes. The minimum measurable flow rate is ~6l/h. The minimum electrical power is ~6W.

For understanding, here is the example of the kWh meter:

One unit, here kWh, consists of 1000 pulses. Hence the setting:

⇒ „Number of pulses per unit“ = 1000

Depending on the DPT, the multipliers and divisors are then set:

⇒ Multiplier „Counter“:

4Byte DPT 13.010 Active Energy (Wh) = 1000

4Byte DPT 13.013 Active Energy (kWh) = 1

⇒ Divisor „Counter“:

4Byte DPT 13.010 Active Energy (Wh) = 1

4Byte DPT 13.013 Active Energy (kWh) = 1

⇒ Multiplier „Power“:

4Byte DPT14.056 Value Power (W) = 1000

2Byte DPT9.024 Value Power (kW) = 1

⇒ Divisor „Power“:

4Byte DPT14.056 Value Power (W) = 1

2Byte DPT9.024 Value Power (kW) = 1

Counter memory

The counter values are saved and restored in the event of bus voltage failure/return and after reprogramming. Deleting the counter reading is only possible via the communication object "Reset counter".

Counter with changed start value

It is possible to set an individual counter reading per object. This is done via the object "Counter reading". It is important that the "Write"-flag is active. This setting is helpful if a counter is not to start with "0" but with an individual value.

Notes:

Datapoint type „Counter“:

- The momentary value is calculated and transmitted with each pulse, but never faster than 1min. For pulses >10min, the momentary value is interpreted as „0“.

Counter function „Water/Gas (m³)“ for Binary Input:

- For counter „DTP14.076“: „Send on counter change of“ – Selection limited to „1 m³“.
- For counter „DTP 14.xxx“: Only integer values are output.
- For counter „DTP9.xxx“: Only tenths of values are output.

Counter function „Water/Gas (m³)“ for Universal Interface:

- For counter „DTP14.076“: „ Send on counter change of“ – For selection only „0.1 m³/1 m³“.
- For counter „DTP 14.xxx“: Only tenths of values are output.
- For counter „DTP9.xxx“: Only tenths of values are output.

Cyclic sending:

- Cyclic sending refers to the momentary value and the counter value.

The following table shows the available communication objects:

| Number | Name/Object Function | Length | Usage |
|--------|-------------------------------|----------------------------|---|
| 0 | Input A: Counting pulse | 1 Bit | Sending the counting pulses. (Counter type: Pulse telegram (Divisor)) |
| 0 | Input A: Threshold counter | 1 Bit | Sends the ON telegram when the threshold value is reached. (Counter type: Simple counter - 1Bit switching) |
| 0 | Input A: Counter reading | 1 Byte 2 Byte 4 Byte | Sends the current counter reading. Can also describe the counter reading, the "S" flag must be active for this. DPT depending on the parameter setting. |
| 1 | Input A: Momentary value | 1 Byte 2 Byte 4 Byte | Sends out the momentary value. (Meter type: Consumption counter - Individual). DPT depending on the parameter setting |
| 1 | Input A: Electrical power | 2 Byte 4 Byte | Sends out the current electrical power. (Meter type: Consumption counter - power). DPT depending on the parameter setting |
| 1 | Input A: Flow rate | 2 Byte 4 Byte | Sends out the current flow rate. (Meter type: Consumption counter - Water/Gas). DPT depending on the parameter setting |
| 2 | Input A: Reset counter | 1 Bit | Resets the counter with a "1" |

Table 33: Communication objects – Counter

4.3.10 LED output

Channels single

Important: This function is only available for Universal Interface!

The following figure shows the available settings:

Figure 36: Settings – LED output

The following table shows the available settings:

| ETS-Text | Dynamic range [Default value] | Comment |
|-------------------------------------|---|--|
| Output active at | <ul style="list-style-type: none"> • Value 1 • Value 0 | Defines the direction of action of the LED |
| LED behaviour | <ul style="list-style-type: none"> • ON • blinking • impulse 0,5s | Defines the lighting behaviour of the LED when it is switched on. |
| Behaviour at undefined object state | <ul style="list-style-type: none"> • OFF • short flashing pulse | Defines the behaviour of the LED if the object has not yet received a value. |

Table 34: Settings – LED output

With this function, LEDs can be controlled at the output without any additional circuitry. The Universal Interface provides the necessary supply voltage as well as a contact current. A series resistor is permanently integrated, and the voltage is set to approx. 2V DC at approx. 1mA current. Since the LEDs are supplied with voltage via the bus, the output current for the LEDs is very low. The values are designed for the use of "low current LEDs" to exclude an overload of the bus system. For the LED output, the direction of action and the lighting behaviour of the LED can be configured. The setting "Output active at" defines the value (1 or 0) with which the LED is controlled. The LED behaviour can be used to set whether a controlled LED is to be switched on permanently, blinking evenly or only with a short pulse of 0.5s. A behaviour in the case of an undefined state (no value received yet) can also be defined.

The communication object for the LED output is a 1-bit object and can therefore be controlled via the normal switching function. This makes it possible, for example, to assign one channel as a switching output and the other channel as an LED output, which then indicates the switching behaviour of the switching output.

The following table shows the available communication objects:

| Number | Name/Object Function | Length | Usage |
|--------|----------------------|--------|--|
| 0 | LED output A: Switch | 1 Bit | Switching the LED at the output of the respective channel. |

Table 35: Communication objects – LED output

4.4. Logic

The devices have 4 (with 2/4/6/8/16 inputs) or 8 (with 32-fold Binary Input) individually switchable and individually programmable logic modules.

The following settings for the individual logics are available (here 4-fold Binary Input):

| | | |
|------------------|----------------------------|---|
| General settings | Description of function | <input type="text"/> |
| + Inputs A-D | Additional text | <input type="text"/> |
| - Logic | Setting Logic | AND (Logic is True if all inputs are value 1) ▼ |
| | Object type | switch ▼ |
| | Sending condition | on change of output ▼ |
| | Output inverted | <input checked="" type="radio"/> no <input type="radio"/> yes |
| Logic 1: | Logic object 1A (external) | not active ▼ |
| Logic 2: | Logic object 1B (external) | not active ▼ |
| Logic 3: | Input A | not active ▼ |
| Logic 4: | Input B | not active ▼ |
| | Input C | not active ▼ |
| | Input D | not active ▼ |

Figure 37: Settings – Logic

For each logic, two text fields are available for free labelling:

| | |
|-------------------------|---|
| Description of function | <input type="text" value="Window contacts"/> |
| Additional text | <input type="text" value="Central monitoring, Ground floor"/> |

Texts with up to 40 characters can be entered for both fields.

The text entered for the “**Description of function**” appears both in the menu behind the corresponding logics and with the communication objects:

| | |
|---------|--------------------------|
| - Logic | |
| | Logic 1: Window contacts |
| | Logic 1: Window contacts |

The “**Additional text**” is merely additional information about the function. This text is not visible anywhere else.

Note: The behaviour after bus voltage return is defined in the general settings. If “Input values for logics -> request” is active, the external objects are requested for their status and the logic operation is re-evaluated. If there is no response, the default settings apply. If the request is not active, the pre-setting’s of the external logic objects apply.

The following table shows all available settings:

| ETS-Text | Dynamic range [Default value] | Comment |
|---|---|--|
| Logic 1-4 (1-8) | <ul style="list-style-type: none"> ▪ not active ▪ AND (Logic is True if all inputs are value 1) ▪ OR (Logic is True if at least one input is value 1) ▪ Send value when contact is closed | Activating the logic function and setting the logical operation. |
| Object type | <ul style="list-style-type: none"> ▪ switch ▪ scene ▪ value ▪ forcible control 2Bit | Setting the object type for the logic output. |
| Scene number/ 1Byte Value/ Forcible control | Any value according to DPT | Setting of the value which is sent when the logic operation is fulfilled. Only available with object types: scene / value / forcible control 2Bit |
| Sending condition | <ul style="list-style-type: none"> ▪ not automatic ▪ on input telegram/contact change ▪ on change of output ▪ on change of output (send only 0) ▪ on change of output (send only 1) | Only for object type "Switch". The sending condition and a sending filter can be set when the logic output sends. |
| Output inverted | <ul style="list-style-type: none"> ▪ no ▪ yes | Only for object type "Switch". Determines whether the output signal should be inverted or not. |
| Logic object 1 A/B (external) | <ul style="list-style-type: none"> ▪ not active ▪ normally active, with preallocation 0 ▪ inverted active, with preallocation 0 ▪ normally active, with preallocation 1 ▪ inverted active, with preallocation 1 | Activation of the external logic objects. The preallocation defines the value of the external logic object after a bus voltage return, if no value has yet been sent to the communication object. |
| Input A-D / A-H / A-P / A1-P2 (According to the device) | <ul style="list-style-type: none"> ▪ not active ▪ contact closed = Value 1 ▪ contact closed = Value 0 | Activation of the inputs and definition of the value that is sent when closing. |

Table 36: Settings – Logic

If a logic operation is fulfilled, the corresponding value is sent out. For the object type "switch", a sending condition or a sending filter can also be defined, e.g., send with every input telegram, only send if the output changes or only send a 1 or 0. In addition, the output can be inverted for the object type "switch".

Application example - Central monitoring of the window contacts

For example, when leaving the house and you want to make sure that all windows are closed, you can implement this with an OR logic. All channels of a unit can be included in a logic.

With the BE-16000.02, you can monitor up to 16 inputs with one logic. As soon as all windows are closed, the logic output signals a "0". If one or more windows are open, a "1" is sent. This signal can then be used, for example, by a status LED to indicate the current status, whether one window is still open, or all are closed. Since the logic objects appear after the channel objects, the object numbers are variable depending on the unit. The object numbers in the following table apply to the units with 2/4/6/8/16/32 channels:

The following table shows the available communication objects:

| Number | Name/Object function | Length | Usage |
|--------------------|----------------------|-------------------------|---|
| 12/24/36/48/96/192 | Logic 1: Input 1A | 1 Bit | Communication object queries external logic object 1. Only shown if external logic object 1 has been activated. |
| 13/25/37/49/97/193 | Logic 1: Input 1B | 1 Bit | According to input logic 1A. |
| 14/26/38/50/98/194 | Logic 1: Output | 1 Bit 2 Bit 1Byte | Output of the logic operation. DPT depending on the parameter setting |

Table 37: Communication objects – Logic

5 Index

5.1 Register of illustrations

| | |
|---|----|
| Figure 1: Connection diagram BE-08000.02 – Version for potential-free contacts..... | 5 |
| Figure 2: Connection diagram BE-08024.02 – Version for 12-24VAC/DC signals..... | 5 |
| Figure 3: Connection diagram BE-08230.02 – Version for 230VAC signals..... | 6 |
| Figure 4: Connection diagram BE-02001.02 | 7 |
| Figure 5: Connection diagram BE-04001.02..... | 7 |
| Figure 6: Connection diagram BE-06001.02 | 7 |
| Figure 7: Connection diagram BE-02230.02..... | 7 |
| Figure 8: Structure & Handling – Binary Input (here for BE-16000.02)..... | 8 |
| Figure 9: Structure & Handling – Universal Interface..... | 9 |
| Figure 10: General Settings..... | 17 |
| Figure 11: Settings – Activate inputs..... | 19 |
| Figure 12: Submenu – Inputs (8-fold and 32-fold)..... | 19 |
| Figure 13: Identical Parameter – Lock object..... | 20 |
| Figure 14: Identical Parameter – Text fields per input/input pair..... | 20 |
| Figure 15: Example – Input/Objects description..... | 20 |
| Figure 16: General Settings – Switch and special functions..... | 21 |
| Figure 17: General Settings – Switch and special functions..... | 22 |
| Figure 18: Settings – Switching for grouped channels..... | 24 |
| Figure 19: Settings – Subfunction: Switching when closing/opening..... | 24 |
| Figure 20: Diagram – Switching when closing (rising edge)..... | 25 |
| Figure 21: Settings – Toggle when closing / opening / closing and opening..... | 26 |
| Figure 22: Diagram – Toggle when opening..... | 26 |
| Figure 23: Settings – Send contact status..... | 28 |
| Figure 24: Diagram – Send contact status..... | 30 |
| Figure 25: Diagram – Send delay..... | 31 |
| Figure 26: Settings – Send values - Subfunction: Send values..... | 32 |
| Figure 27: Settings – Send Values - Subfunction: Toggle values/scenes (up to 4 values)..... | 34 |
| Figure 28: Settings – Send Values - Subfunction: Shift Values..... | 37 |
| Figure 29: Settings – Send values - Subfunction: Send values by state..... | 39 |
| Figure 30: Settings – Send values - Subfunction: Multi-tip function..... | 41 |
| Figure 31: Settings – Switch/send value short/long (with 2 objects)..... | 43 |
| Figure 32: Settings – Scene..... | 45 |
| Figure 33: Settings – Blinds/Shutter..... | 47 |
| Figure 34: Setting – Dimming..... | 50 |
| Figure 35: Settings – Counter..... | 51 |
| Figure 36: Settings – LED output..... | 57 |
| Figure 37: Settings – Logic..... | 58 |

5.2 List of tables

| | |
|--|----|
| Table 1: Communication objects – Standard settings: Inputs | 15 |
| Table 2: Communication objects – Standard settings: Logic | 16 |
| Table 3: General Settings | 17 |
| Table 4: Settings – Activate inputs..... | 19 |
| Table 5: Communication object – Lock object | 20 |
| Table 6: Communication objects – Switching for grouped channels | 24 |
| Table 7: Communication objects – Switching when closing/opening..... | 25 |
| Table 8: Communication objects – Toggle when closing / opening / closing and opening | 27 |
| Table 9: Settings – Send contact status | 29 |
| Table 10: Communication objects – Send contact status | 29 |
| Table 11: Settings – Send values - Subfunction: Send values..... | 33 |
| Table 12: Communication objects – Send values - Subfunction: Send values..... | 34 |
| Table 13: Settings – Send Values - Subfunction: Toggle values/scenes (up to 4 values) | 35 |
| Table 14: Communication objects – Send Values - Subfunction: Toggle values/scenes (up to 4 values) | 36 |
| Table 15: Settings – Send Values - Subfunction: Shift Values | 37 |
| Table 16: Communication objects – Send Values - Subfunction: Shift Values | 38 |
| Table 17: Settings – Send values - Subfunction: Send values by state | 40 |
| Table 18: Communication objects – Send values - Subfunction: Send values by state | 40 |
| Table 19: Settings – Send values - Subfunction: Multi-tip function | 42 |
| Table 20: Communication objects – Send values - Subfunction: Multi-tip function | 42 |
| Table 21: Settings – Switch/send values short/long (with 2 objects) | 44 |
| Table 22: Communication objects – Switch/send values short/long (with 2 objects) | 44 |
| Table 23: Settings – Scene | 45 |
| Table 24: Scene call and save..... | 46 |
| Table 25: Communication object – Scene..... | 46 |
| Table 26: Settings – Blinds/Shutter..... | 47 |
| Table 27: Functional principle – blind for grouped channels..... | 48 |
| Table 28: Communication objects – Blinds/Shutter..... | 49 |
| Table 29: Setting – Dimming | 50 |
| Table 30: Functional principle – Dimming with grouped channels | 50 |
| Table 31: Communication objects – Dimming | 50 |
| Table 32: Settings – Counter | 54 |
| Table 33: Communication objects – Counter | 56 |
| Table 34: Settings – LED output..... | 57 |
| Table 35: Communication objects – LED output..... | 57 |
| Table 36: Settings – Logic..... | 59 |
| Table 37: Communication objects – Logic | 60 |

6 Appendix

6.1 Statutory requirements

The devices described above must not be used in conjunction with devices which directly or indirectly serve human, health, or life-safety purposes. Furthermore, the devices described must not be used if their use may cause danger to people, animals, or property.

Do not leave the packaging material carelessly lying around. Plastic foils/ bags etc. can become a dangerous toy for children.

6.2 Disposal

Do not dispose of the old devices in the household waste. The device contains electrical components that must be disposed of as electronic waste. The housing is made of recyclable plastic.

6.3 Assembly



Danger to life from electric current!

The device may only be installed and connected by qualified electricians. Observe the country-specific regulations and the applicable KNX guidelines

The units are approved for operation in the EU and bear the CE mark. Use in the USA and Canada is not permitted!

Before starting work on the unit, always disconnect it from the power supply via the upstream fuses. After installation, all live terminals and connections must be completely closed by the control panel cover so that they cannot be touched. It must not be possible to open the control panel cover without tools.

6.4 History

V 1.0 First Version, Series .02

DB V3.2

01/2022